

DESIGNED FOR MODERN LIVING

WINTER 2026



BDIUSA.COM

Driven by Design Since 1984.

I have always appreciated the power of good design. Good design is more than how something looks—it is how it functions, how it performs, how it affects us far beyond simply its aesthetic value.

'Designing with purpose' is at the core of BDI. Before we develop any product, we first determine what problem we are trying to solve. Are we creating a workspace that will be more organized and efficient, allowing us to work smarter? Are we engineering a home theater system that will make movie night more special because the focus is on the film and not on the electronics? Are we creating new and innovative ways to integrate today's digital lifestyle into everyday life?

It is this purpose-driven philosophy at the heart of BDI that allows us to create beautifully practical furniture. Yes, we want to create memorable designs that look good, but they must serve a higher purpose. Our collections must have a timeless appeal while still adapting to the ever-changing needs of today's technology.

I hope that you enjoy reviewing this product catalog and discovering the ways that BDI furniture is designed to enhance the ways we work, live, and play.

Thank you.



Bill Becker



BDIUSA.COM

Get to Know **BDI**

Since 1984, BDI has been dedicated to creating uniquely functional, streamlined, and meticulously executed furniture. Although our designs have earned dozens of awards and legions of fans, that doesn't mean we ever want to rest on our laurels.

We're known for 'sweating the details' and that attention to detail goes far beyond just the products that we create. It is evident in the way that we operate every day.

Whether its our strong inventory availability, best-in-class website, ongoing sales & marketing support, national promotions, world-class customer service, thoughtful packaging, or any of the elements that go into doing business with BDI, we want to make it a pleasure to work with us.

See just some of the ways that BDI makes doing business easy on the next page.

Reach out anytime.

customerservice@bdiusa.com



Sales

- Dedicated Sales Support
- National Sales Promotions
- Stock Ships from Virginia Distribution Center
- Quick Shipment
- Published MAP & Internet Policies
- Prepaid Logistics Program
- Product Training Modules

Customer Service

- Responsive Customer Support
- Online & EDI Ordering
- Real-Time Inventory Feed

Marketing

- National Advertising Support
- Modern & Responsive Website
- Social Media & Other Content
- Point-of-Sale Materials
- Marketing Resource Access
- 3D GLB, Floorplanner & SketchUp Models

Operations

- Virginia-based Design & Product Development Team
- Smart Packaging / Minimal Waste
- Rigorous Quality Control



Connect. Recharge. **Dream.**



BDIUSA.COM

BEDROOM

BEDROOM

With a dreamy combination of impressive design, innovative features, and natural wood grains, a BDI bedroom is engineered for much more than simply a restful night's sleep.

Hidden within its exceptional design are unique features that enhance how we interact with today's technology. From fully adjustable bed frames to integrated power management and uniquely functional side tables—the entire bedroom experience has been reimaged from the ground up as only the BDI team could do it.

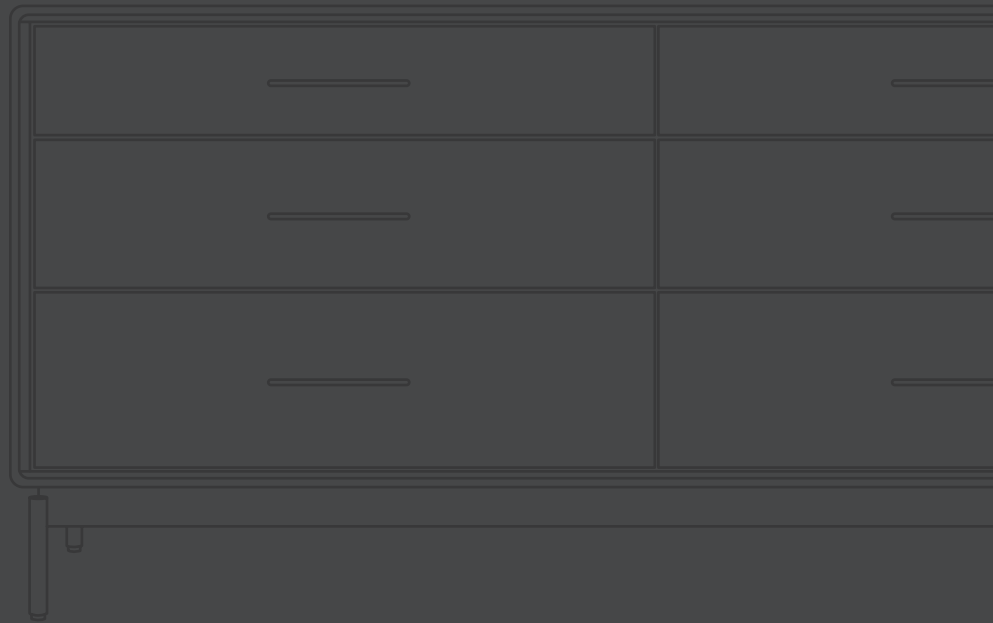



CONTINUUM™

BD

CONTINUUM™

DESIGN **MATTHEW WEATHERLY**

Rotating on its swivel base, Continuum features a full-length mirror floating within a solid wood beveled perimeter.

3472 STANDING MIRROR

Dimensions 64.5H x 18.5 x 18.5 in | 164H x 47 x 47 cm
Weight 64 lbs | 29 kg

For product info and detailed specs, visit [bdiusa.com/continuum](https://www.bdiusa.com/continuum)

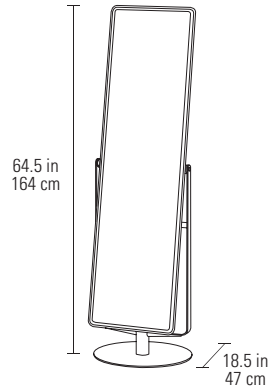
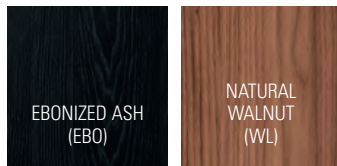

Continuum features a beveled wood panel floating within a sturdy steel frame, rotating a full 360° on its weighted base.



BDI's products are packaged with recyclable materials. Dimensions, specifications, and availability are subject to change. For current specifications and availability, visit www.bdiusa.com. Listed capacities assume even distribution of weight. BDI's designs are protected by US and international patents, trade dress, and/or copyright laws. "Continuum" and BDI are trademarks of Becker Designed Inc. All rights reserved. ©2023, BDI

CONTOUR™

BDI



CONTOUR™

DESIGN **MATTHEW WEATHERLY**

Add an extra layer of comfort to a LINQ or KAVA headboard with this sleek accessory—perfect for reading, working, or just kicking back. The Contour headboard cushion is comfortable yet slim—just a few inches thick—and available in both performance fabric and genuine leather, providing a sleek addition without taking up too much space.

QUEEN HEADBOARD CUSHION

Dimensions 19H x 61.5 x 3 in
48H x 155 x 8 cm
Weight 25 lbs | 11 kg

KING HEADBOARD CUSHION

Dimensions 19H x 77.5 x 3 in
48H x 196 x 8 cm
Weight 34 lbs | 15 kg

9667 FABRIC



9669 FABRIC



9677 LEATHER



9679 LEATHER



For product info and detailed specs, visit
bdiusa.com/contour

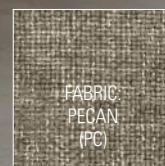

BDI's products are packaged with recyclable materials. Dimensions, specifications, and availability are subject to change. For current specifications and availability, visit www.bdiusa.com. Listed capacities assume even distribution of weight. BDI's designs are protected by US and international patents, trade dress, and/or copyright laws. "Contour" and BDI are trademarks of Becker Designed Inc. All rights reserved. ©2025, BDI

KAVVA™ BENCH

BDI



KAVA™ BENCH

DESIGN **MATTHEW WEATHERLY**

The KAVA Bench offers a versatile seating solution, perfect for the foot of the bed or as an accent in entryways, hallways, or mudrooms. With a clean, minimalist design, it seamlessly complements the KAVA collection and modern interiors.

- Functions as a dressing bench at the foot of the bed or a stylish accent in entryways, hallways, and mudrooms
- Minimalist design integrates effortlessly with the KAVA collection and modern décor
- Crafted with durable materials for long-lasting style and everyday use

9600 BENCH

Dimensions	17H x 59 x 17 in 43H x 150 x 43 cm
Capacity	350 lbs 158 kg
Weight	56 lbs 25 kg

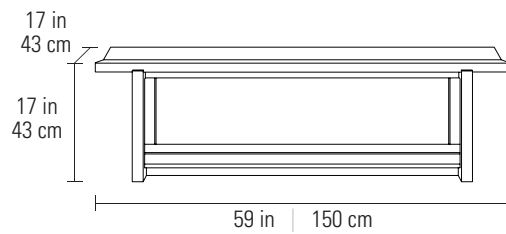

For product info and detailed specs, visit
bdiusa.com/kava

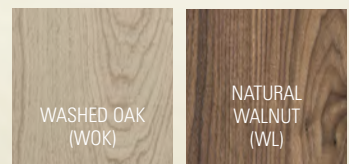

BDI's products are packaged with recyclable materials. Dimensions, specifications, and availability are subject to change. For current specifications and availability, visit www.bdiusa.com. Listed capacities assume even distribution of weight. BDI's designs are protected by US and international patents, trade dress, and/or copyright laws. "KAVA" and BDI are trademarks of Becker Designed Inc. All rights reserved. ©2025, BDI

KAVVA™

BD



KAVA™

DESIGN **MATTHEW WEATHERLY**

The KAVA Bed is the bold centerpiece of the collection, featuring a striking geometric headboard with a floating panel design. Thoughtful details like dimmable lighting, integrated USB-C charging, and an adjustable frame combine modern aesthetics with everyday comfort.



9617 QUEEN BED

Dimensions 45.5H x 72 x 89 in
116H x 183 x 225 cm
Weight 212 lbs | 96 kg



9619 KING BED

Dimensions 45.5H x 88 x 89 in
116H x 224 x 225 cm
Weight 262 lbs | 119 kg

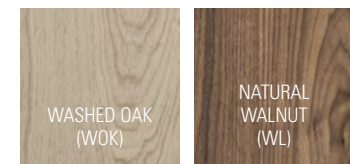

SAVE THE WALLS

Wall levelers extend up to 2" | 5 cm, securing the headboard away from the wall.

CONTOURED EDGE

The bed frame's inner edge is beveled inward to provide a comfortable surface when making the bed.

THOUGHTFUL DESIGN

Rounded edges and recessed legs ensure late-night trips to the fridge don't result in bruised shins or stubbed toes.

CUSHIONED SUPPORT

The bed's inner platform features full-width solid pine slats enveloped in soft upholstery, making installation simple and keep vibration to a minimum.

DIMMABLE LIGHTING TOUCHBAR

An easily-accessible sensor in the top of the headboard responds to your touch, dimming the light or turning it on or off at command.

NATURAL WOOD

The intelligent combination of hardwood solids and veneers ensures each bed is a unique work of nature.



FULLY CONFIGURABLE

The unique platform and bed frame can be placed at four heights, accommodating mattresses of any size. The platform can be removed, if needed, for use with an adjustable bed frame.



POWER UP

Two USB-C outlets are concealed behind either side of the headboard, providing a convenient charging spot for computers or rechargeable items.

SO MANY WAYS TO MAKE YOUR BED

The bed's adjustable platform and frame allow KAVA to accommodate various mattress sizes, positioning the mattress at the user's preferred height. The full-width upholstered slatted platform provides sturdy, ventilated support for mattresses 8" to 16" tall—or more, or can be removed for use with an adjustable bed frame.

PLATFORM ADJUSTMENT

Switching the inner platform from the HIGH to LOW position drops the platform 3" for use with taller mattresses.

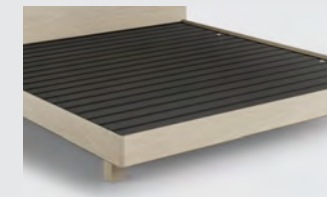
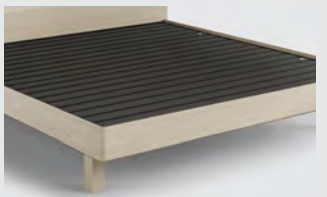

Platform Position: High
Frame Position: High
Platform Height: 14 in | 36 cm

Platform Position: High
Frame Position: Low
Platform Height: 11 in | 28 cm

FRAME ADJUSTMENT

The bed's frame can be positioned HIGH or LOW by utilizing the included leg options, changing the entire frame height by 3".

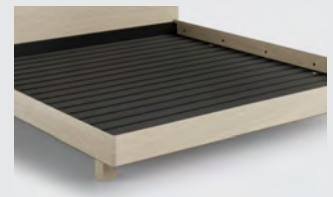

Platform Position: Low
Frame Position: High
Platform Height: 11 in | 28 cm

Platform Position: Low
Frame Position: Low
Platform Height: 8 in | 21 cm



For product info and detailed specs, visit
bdiusa.com/kava



BDI's products are packaged with recyclable materials. Dimensions, specifications, and availability are subject to change. For current specifications and availability, visit www.bdiusa.com. Listed capacities assume even distribution of weight. BDI's designs are protected by US and international patents, trade dress, and/or copyright laws. "KAVA" and BDI are trademarks of Becker Designed Inc. All rights reserved. ©2025, BDI



KAVA™ NIGHTSTAND

DESIGN **MATTHEW WEATHERLY**

Blending convenience with timeless design, KAVA Nightstands feature a sliding top for easy bedside access and a hidden power center to keep devices charged. A removable velvet-lined tray and textured black drawer interiors elevate organization with refined elegance.

- Sliding top panel extends forward for convenient access and reveals a hidden power center
- Integrated power station with AC, USB-A, and USB-C outlets for seamless charging
- Removable velvet-lined drawer tray provides organized storage for accessories
- Textured black drawer interiors add a refined, high-end look

9681 20" NIGHTSTAND

Dimensions	21H x 20 x 20.5 in 54H x 51 x 52 cm
Top Panel Extension	8 in 20 cm
Top Capacity	50 lbs 23 kg
Weight	66 lbs xx kg

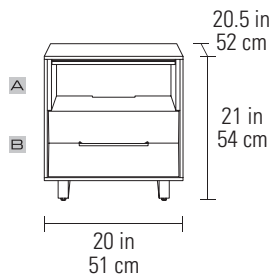

A Shelf

Dimensions	6.5H x 17.75 x 16.75 in 17H x 46 x 43 cm
Capacity	35 lbs 16 kg

B

Drawer

Dimensions	6.75H x 16 x 14.25 in 17H x 41 x 36 cm
Capacity	25 lbs 11 kg



STORAGE WITH INTENTION

A removable velvet-lined tray makes it easy to organize small accessories like glasses, jewelry, or chargers—keeping them within reach, yet neatly stored away.



WITHIN REACH

A smooth-gliding top extends forward for easy access while sitting up in bed, while also revealing a hidden power center at the back for seamless charging.

KAVA™ NIGHTSTAND

9682 28" NIGHTSTAND

Dimensions	21H x 28 x 20.5 in 54H x 72 x 52 cm
Top Panel Extension	8 in 20 cm
Top Capacity	50 lbs 23 kg
Weight	85 lbs 39 kg

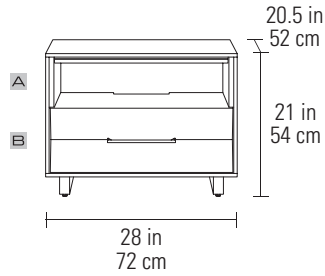

A Shelf

Dimensions	6.5H x 25.75 x 16.75 in 17H x 70 x 43 cm
Capacity	35 lbs 16 kg

B Drawer

Dimensions	6.75H x 25.25 x 14.25 in 17H x 61 x 36 cm
Capacity	35 lbs 16 kg



STAY CONNECTED

AC, USB-A, and USB-C outlets keep all your essentials powered up, whether it's your phone, lamp, or smartwatch—without cluttering your nightstand with tangled cords.



A TOUCH OF SOPHISTICATION

The textured black drawer interiors add an elegant contrast to the natural wood finishes while creating a polished, high-end feel inside and out.

KAVA™ NIGHTSTAND



For product info and detailed specs, visit
bdiusa.com/kava



WASHED OAK
(WOK)



NATURAL
WALNUT
(WL)



BDI's products are packaged with recyclable materials. Dimensions, specifications, and availability are subject to change. For current specifications and availability, visit www.bdiusa.com. Listed capacities assume even distribution of weight. BDI's designs are protected by US and international patents, trade dress, and/or copyright laws. "KAVA" and BDI are trademarks of Becker Designed Inc. All rights reserved. ©2025, BDI

KAVVA™ CHEST



BDI

KAVA™ CHEST

DESIGN **MATTHEW WEATHERLY**

The KAVA 5-Drawer Chest offers ample storage in a sleek, modern profile. Soft-close drawers glide smoothly, while a removable velvet-lined tray adds flexible organization. A STURDY-compliant interlock system enhances safety, allowing only one drawer to open at a time.

- Five full-extension, soft-close drawers with hidden glides
- Removable velvet-lined accessory tray for customizable storage
- STURDY-compliant interlock system for enhanced safety
- Durable hardwood veneer over an engineered wood core

9685 5-DRAWER CHEST

Dimensions 52H x 32 x 20.5 in
132H x 82 x 52 cm

Top Shelf Capacity 100 lbs | 45 kg

Weight 225 lbs | 102 kg

Drawers

Drawer (x5) 6.5H x 28.25 x 16.25 in
17H x 72 x 41 cm

Drawer Capacity 25 lbs | 11 kg

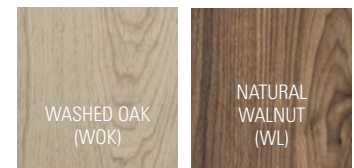
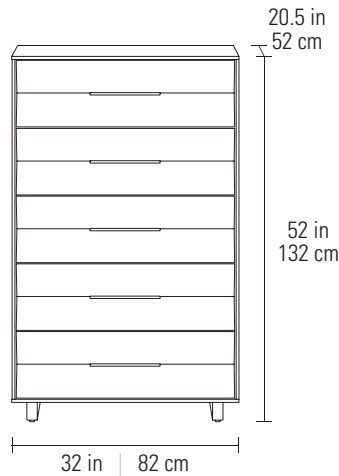

For product info and detailed specs, visit
bdiusa.com/kava



BDI's products are packaged with recyclable materials. Dimensions, specifications, and availability are subject to change. For current specifications and availability, visit www.bdiusa.com. Listed capacities assume even distribution of weight. BDI's designs are protected by US and international patents, trade dress, and/or copyright laws. "KAVA" and BDI are trademarks of Becker Designed Inc. All rights reserved. ©2025, BDI

KAVVA™ DRESSER

BD



KAVA™ DRESSER

DESIGN **MATTHEW WEATHERLY**

The KAVA 6-Drawer Dresser offers generous storage with a refined, modern aesthetic. Soft-close drawers glide smoothly, while a removable velvet-lined tray adds flexible organization.

- Six full-extension, soft-close drawers with hidden glides
- Removable velvet-lined accessory tray for customizable storage
- STURDY-compliant interlock system allows only one drawer per side to open at a time
- Durable hardwood veneer over an engineered wood core



9686 6-DRAWER DRESSER

Dimensions 33H x 63.5 x 20.5 in
84H x 161 x 52 cm

Top Shelf Capacity 100 lbs | 45 kg

Weight 287 lbs | 130 kg

Drawers

Drawer (x6) 6.5H x 28.25 x 16.25 in
17H x 72 x 41 cm

Drawer Capacity 25 lbs | 11 kg

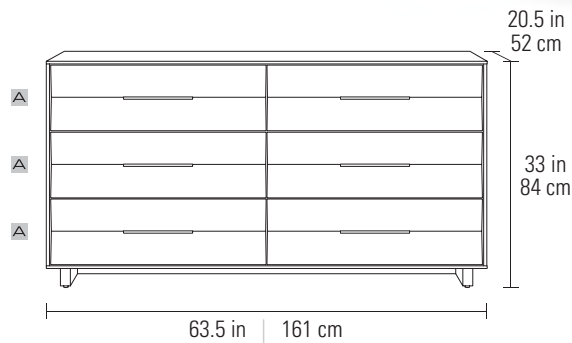

For product info and detailed specs, visit bdiusa.com/kava

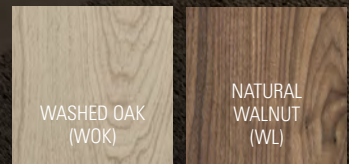

BDI's products are packaged with recyclable materials. Dimensions, specifications, and availability are subject to change. For current specifications and availability, visit www.bdiusa.com. Listed capacities assume even distribution of weight. BDI's designs are protected by US and international patents, trade dress, and/or copyright laws. "KAVA" and BDI are trademarks of Becker Designed Inc. All rights reserved. ©2025, BDI



LING® BENCH

BD

LINQ® BENCH

DESIGN **MATTHEW WEATHERLY**

The LINQ Bench offers versatile seating with hidden storage, concealed behind two smooth-gliding doors that keep essentials neatly tucked away.

- Designed for the bedroom, entryway, or any space needing extra seating and organization.
- The comfortable upholstered seat is available in semi-aniline leather or performance fabric, blending comfort with a modern aesthetic.
- Solid wood, hardwood veneer, and a powder-coated steel base ensure stability and durability.



9101 FABRIC CUSHION

Dimensions 18H x 60 x 16 in
46H x 152 x 41 cm
Capacity 350 lbs | 159 kg
Weight 89 lbs | 41 kg

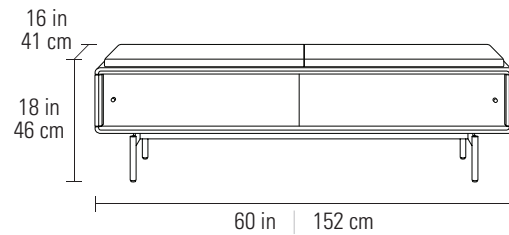

WOOD FINISH

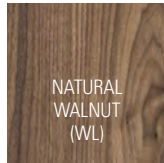
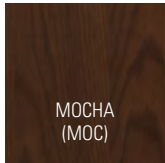

CUSHION FINISH



LINQ® BENCH

9102 LEATHER CUSHION

Dimensions 18H x 60 x 16 in
46H x 152 x 41 cm
Capacity 350 lbs | 159 kg
Weight 89 lbs | 41 kg

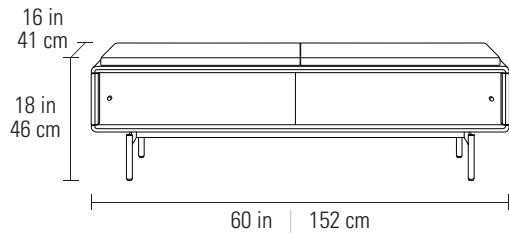

WOOD FINISH

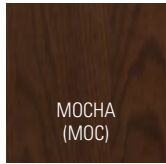

MOCHA
(MOC)

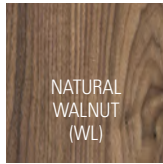

NATURAL
WALNUT
(WL)

CUSHION FINISH



PEPPER
(PE)



For product info and detailed specs, visit
bdiusa.com/linq



BDI's products are packaged with recyclable materials. Dimensions, specifications, and availability are subject to change. For current specifications and availability, visit www.bdiusa.com. Listed capacities assume even distribution of weight. BDI's designs are protected by US and international patents, trade dress, and/or copyright laws. "LINQ" and BDI are trademarks of Becker Designed Inc. All rights reserved. ©2025, BDI



LINQ® MIRRORS

DESIGN **MATTHEW WEATHERLY**

LINQ mirror's beveled wood detail surrounds the inner mirror, creating the impression that the reflection is floating within the natural wood frame. Available in a round and rectangular design in Natural Walnut.

9190 WALL MIRROR—ROUND

Dimensions 32H x 32 x 1.5 in | 82H x 82 x 4 cm
Weight 16 lbs | 7 kg

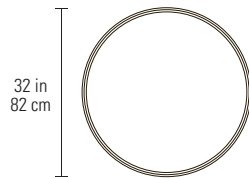

9194 WALL MIRROR—RECTANGLE

Dimensions 44 x 30 x 1.5 in | 112 x 77 x 4 cm
Weight 29 lbs | 13 kg

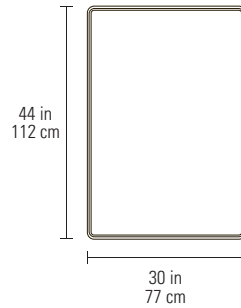

For product info and detailed specs, visit [bdiusa.com/linq](https://www.bdiusa.com/linq)



BDI's products are packaged with recyclable materials. Dimensions, specifications, and availability are subject to change. For current specifications and availability, visit www.bdiusa.com. Listed capacities assume even distribution of weight. BDI's designs are protected by US and international patents, trade dress, and/or copyright laws. "Linq" and BDI are trademarks of Becker Designed Inc. All rights reserved. ©2023, BDI



CROSS-LING®

BDI

CROSS-LINQ®

DESIGN **MATTHEW WEATHERLY**

Cross-LINQ's lateral hardwood details are prone to leave you feeling level and on an even keel at the end of the day. With its dreamy combination of impressive design, innovative features, and organic wood grains, the LINQ collection is engineered for today's connected lifestyle. Hidden within its exceptional design are unique features that enhance how we live with today's technology.



9127 QUEEN BED

Dimensions 45.25H x 65.75 x 85 in
115H x 167 x 216 cm
Weight 183 lbs | 83 kg



9129 KING BED

Dimensions 45.25H x 81.75 x 85 in
115H x 208 x 216 cm
Weight 204 lbs | 96 kg



SAVE THE WALLS

Wall levelers extend up to 2" | 5 cm, securing the headboard away from the wall.

CONTOURED EDGE

The bed frame's inner edge is beveled inward to provide a comfortable surface when making the bed.

THOUGHTFUL DESIGN

Rounded edges and recessed legs ensure late-night trips to the fridge don't result in bruised shins or stubbed toes.

CUSHIONED SUPPORT

The bed's inner platform features full-width solid pine slats enveloped in soft upholstery, making installation simple and keep vibration to a minimum.

NATURAL WALNUT

The intelligent combination of hardwood solids and veneers ensures each bed is a unique work of nature.



FULLY CONFIGURABLE

The unique platform and bed frame can be placed at four heights, accommodating mattresses of any size. The platform can be removed, if needed, for use with an adjustable bed frame.



PLUG IN

The headboard's two concealed charging stations include a USB-A and a USB-C outlet for convenient late night charging sessions.

SO MANY WAYS TO MAKE YOUR BED

The bed's adjustable platform and frame allow LINQ to accommodate various mattress sizes, positioning the mattress at the user's preferred height. The full-width upholstered slatted platform provides sturdy, ventilated support for mattresses 8" to 16" tall—or more, or can be removed for use with an adjustable bed frame.

PLATFORM ADJUSTMENT

Switching the inner platform from the HIGH to LOW position drops the platform 3" for use with taller mattresses.

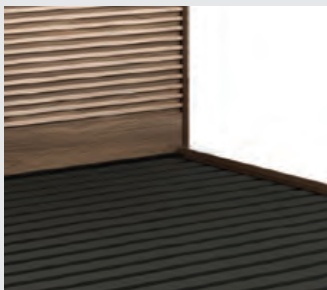

Platform Position: High
Frame Position: High
Platform Height: 14 in | 36 cm
(10" Mattress shown)



Platform Position: High
Frame Position: Low
Platform Height: 11 in | 28 cm
(12" Mattress shown)



Platform Position: Low
Frame Position: High
Platform Height: 11 in | 28 cm
(12" Adjustable Mattress shown)



Platform Position: Low
Frame Position: Low
Platform Height: 8 in | 21 cm
(14" Mattress shown)



Cross-LINQ 9129 King Bed with LINQ Chest and 22" Nightstands



BDI's products are packaged with recyclable materials. Dimensions, specifications, and availability are subject to change. For current specifications and availability, visit www.bdiusa.com. Listed capacities assume even distribution of weight. BDI's designs are protected by US and international patents, trade dress, and/or copyright laws. "LINQ", "Cross-LINQ", and BDI are trademarks of Becker Designed Inc. All rights reserved. ©2023, BDI



UP-LING®

BDI

UP-LINQ®

DESIGN **MATTHEW WEATHERLY**

With a dreamy combination of organic wood grains, impressive design, and innovative features, the LINQ collection is engineered for today's connected lifestyle. Hidden within the exceptional design are unique features designed to enhance how we live with today's technology. From fully adjustable bed frames with integrated power management and uniquely functional nightstands, the entire bedroom experience has been re-imagined from the ground up.



9117 QUEEN BED

Dimensions 45.25H x 72 x 86.75 in
115H x 183 x 220 cm
Weight 194 lbs | 88 kg



9119 KING BED

Dimensions 45.25H x 88 x 86.75 in
115H x 224 x 220 cm
Weight 218 lbs | 99 kg

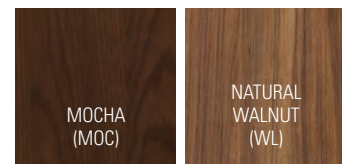

DIMMABLE LIGHTING TOUCHBAR

An easily-accessible sensor in the top of the headboard responds to your touch, dimming the light or turning it on or off at command.

NATURAL WALNUT

The intelligent combination of hardwood solids and veneers ensures each bed is a unique work of nature.

SAVE THE WALLS

Wall levelers extend up to 2" | 5 cm, securing the headboard away from the wall.

CONTOURED EDGE

The bed frame's inner edge is beveled inward to provide a comfortable surface when making the bed.

THOUGHTFUL DESIGN

Rounded edges and recessed legs ensure late-night trips to the fridge don't result in bruised shins or stubbed toes.

CUSHIONED SUPPORT

The bed's inner platform features full-width solid pine slats enveloped in soft upholstery, making installation simple and keep vibration to a minimum.

FULLY CONFIGURABLE

The unique platform and bed frame can be placed at four heights, accommodating mattresses of any size. The platform can be removed, if needed, for use with an adjustable bed frame.

POWER UP

A power strip is concealed on both sides of the bed, providing a convenient charging spot. Each power center includes three standard outlets and one USB-A and USB-C outlet.



SO MANY WAYS TO MAKE YOUR BED

The bed's adjustable platform and frame allow LINQ to accommodate various mattress sizes, positioning the mattress at the user's preferred height. The full-width upholstered slatted platform provides sturdy, ventilated support for mattresses 8" to 16" tall—or more, or can be removed for use with an adjustable bed frame.

PLATFORM ADJUSTMENT

Switching the inner platform from the HIGH to LOW position drops the platform 3" for use with taller mattresses.

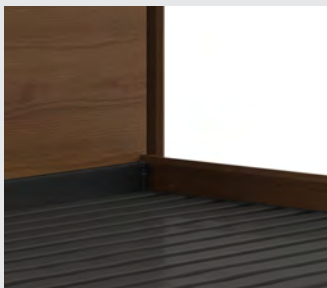

Platform Position: High
Frame Position: High
Platform Height: 14 in | 36 cm
(10" Mattress shown)



Platform Position: High
Frame Position: Low
Platform Height: 11 in | 28 cm
(12" Mattress shown)



Platform Position: Low
Frame Position: High
Platform Height: 11 in | 28 cm
(12" Adjustable Mattress shown)



Platform Position: Low
Frame Position: Low
Platform Height: 8 in | 21 cm
(14" Mattress shown)



Up-LINQ 9119 King Bed with 28" Nightstands



LING[®] NIGHTSTANDS

BD



LINQ® NIGHTSTANDS

DESIGN **MATTHEW WEATHERLY**

Available in two sizes and configurations, Linq nightstands are the ideal bedside companion. With an integrated power hub, a sliding top panel that brings the entire top surface forward for easier reach, and generous storage, these tables are one-part nightstand and two-parts command center.

9181 22" NIGHTSTAND

Dimensions	25H x 22 x 20 in 64H x 56 x 51 cm
Top Panel Extension	8 in 20 cm
Top Capacity	50 lbs 23 kg
Weight	79 lbs 36 kg

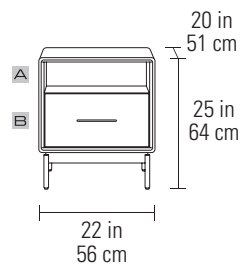

A Shelf

Dimensions	5.25H x 20 x 15.25 in 14H x 50 x 39 cm
Capacity	35 lbs 16 kg

B Drawer

Dimensions	8H x 18.25 x 13 in 21H x 46 x 33 cm
Capacity	25 lbs 11 kg



STORE AND MORE

More than simply a place to keep your books, lotions and potions, Linq nightstands are high performance engineered to keep your everyday electronics recharged and accessible.



OUT IN FRONT

Both Linq nightstands feature a unique sliding top. This provides easy access to the table's power supply in the back and extends the top surface forward, putting everything within better reach while lying in bed.



9182 28" NIGHTSTAND

Dimensions 25H x 28 x 20 in
64H x 71 x 51 cm

Top Panel Extension 8 in | 20 cm

Top Capacity 50 lbs | 23 kg

Weight 101 lbs | 46 kg

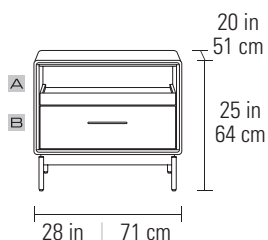

A Pull Out Tray

Dimensions 4.75H x 24.75 x 15.25 in
12H x 63 x 38 cm

Extension 14 in | 35.5 cm

Capacity 35 lbs | 16 kg

B Drawer

Dimensions 6.5H x 24.25 x 13 in
16H x 62 x 33 cm

Capacity 35 lbs | 16 kg



POWERED FOR THE PEOPLE

The nightstands include a power strip conveniently positioned to allow the connection of a lamp, clock, sound machine, air purifier, and charging cords. The strip includes three standard outlets and one USB-A and USB-C outlet. Excess wires can be neatly organized around the included wire wraps.



CHARGE FORWARD

The 28" nightstand includes a pull-out lower shelf with a wire management back panel that keeps charging cables under control. The shelf's raised perimeter keeps contents secure.

When used with an adjustable mattress, the lower shelf becomes a particularly convenient location to access from a raised position.



Linq 9182 28" Nightstand



Linq 9181 22" Nightstand



LING® CHEST

BD



LINQ® CHEST

DESIGN **MATTHEW WEATHERLY**

9185 5-DRAWER CHEST

Tall and modern, the Linq 5-drawer chest stands strong on its sturdy foundation. Five roomy drawers slide effortlessly on hidden drawer glides, self-closing with a gentle push.

- Designed with safety in mind, Linq storage cabinets are engineered to meet the demanding requirements of the Stop Tip-overs of Unstable, Risky Dressers on Youth (STURDY) Act
- Innovative interlock system allows only one drawer to open at a time
- Included wire wraps attach to the back to keep cords controlled
- Cabinet includes a wall-anchoring kit for added security

Dimensions 50.75H x 35 x 20 in | 129H x 89 x 51 cm
Top Shelf Capacity 100 lbs | 45 kg
Weight 231 lbs | 105 kg

Drawers

Width x Depth 31.25 x 16.25 in | 79 x 41 cm

Drawer Height

- A Drawer 4.5 in | 11 cm
- B Drawer 5.75 in | 15 cm
- C Drawer 5.75 in | 15 cm
- D Drawer 7.25 in | 18 cm
- E Drawer 7.25 in | 18 cm

Drawer Capacity 25 lbs | 11 kg

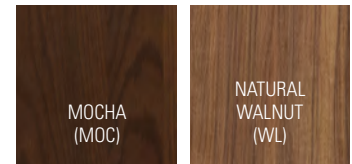
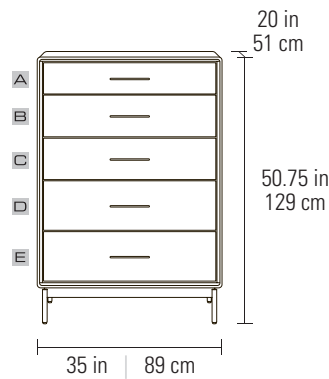

BDI's products are packaged with recyclable materials. Dimensions, specifications, and availability are subject to change. For current specifications and availability, visit www.bdiusa.com. Listed capacities assume even distribution of weight. BDI's designs are protected by US and international patents, trade dress, and/or copyright laws. "LINQ" and BDI are trademarks of Becker Designed Inc. All rights reserved. ©2024, BDI

LING[®] DRESSER

BD



LINQ® DRESSER

DESIGN **MATTHEW WEATHERLY**

9186 6-DRAWER DRESSER

Boasting a wealth of storage, the Linq 6-drawer dresser is an impressive storage cabinet in any room of the house. Roomy drawers slide effortlessly on hidden drawer glides, self-closing with a gentle pull.

- Designed with safety in mind, Linq storage cabinets are engineered to meet the demanding requirements of the Stop Tip-overs of Unstable, Risky Dressers on Youth (STURDY) Act
- Innovative interlock system allows only one drawer on each side to be opened at a time
- Included wire wraps attach to the back to keep cords controlled
- Cabinet includes a wall-anchoring kit for added security

Dimensions	33H x 69 x 20 in 84H x 175 x 51 cm
Top Shelf Capacity	100 lbs 45 kg
Weight	308 lbs 140 kg

Drawers

Width x Depth	31.25 x 16.25 in 79 x 41 cm
Drawer Height	
▲ Drawer	4.5 in 11 cm
■ Drawer	6.5 in 17 cm
□ Drawer	8 in 21 cm
Drawer Capacity	25 lbs 11 kg

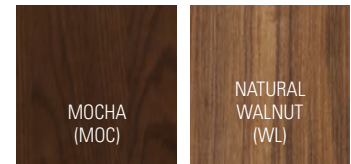
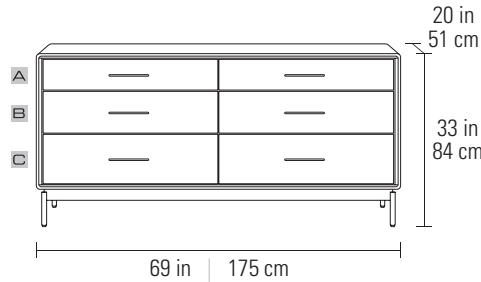

Entertain. Organize. **Protect.**

MEDIA & STORAGE



BDIUSA.COM

MEDIA & STORAGE

Whether creating a home theater where family and friends can stream big, or arranging a living space to store a lifetime of treasures, BDI's media and storage collections feature pieces with exceptional design that are much more than meets the eye.

Our media furniture is intelligently engineered to anticipate the needs of the most demanding entertainment systems. Integrated features like adjustable shelves, cable management, speaker/media storage, and hidden wheels provide simple setup, and make ongoing adjustments a breeze.

BDI's bar storage is high on versatility, with an intoxicating mix of function and style. These beautifully crafted pieces ensure that even the most spontaneous gatherings have a generous selection of beverages and glassware at-the-ready.

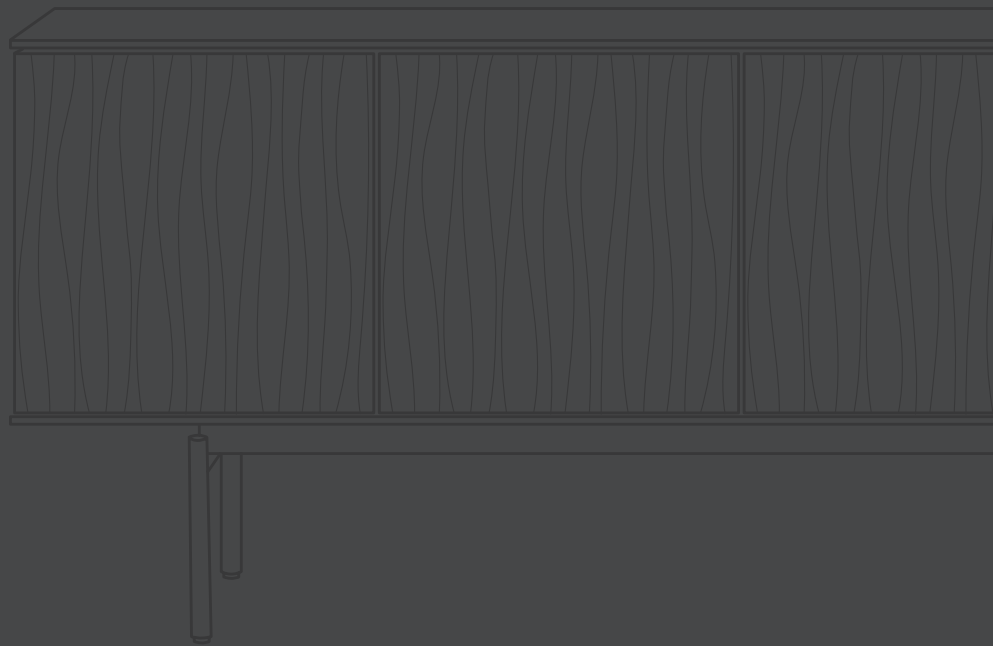

ALIGN™

BDI



ALIGN™

DESIGN **MATTHEW WEATHERLY**

Sleek, streamlined, and downright sexy these consoles are a striking addition to any room. Two base options provide versatility, allowing the cabinet to serve as a full-featured media center or an impressive storage console.

- Louvered design provides acoustic and remote-control transparency
- Removable back panels provide access to the rear of components
- Integrated wire management system keeps cables organized

7473 STORAGE CONSOLE + MEDIA CABINET

Recommended TV Size	up to 85"
Dimensions (Console Base)	23H x 81 x 18 in 58H x 206 x 46 cm
Dimensions (Media Base)	19H x 81 x 18 in 49H x 206 x 46 cm
Component Capacity	6-9
Number of Adjustable Shelves	3
Adjustable Shelf Increments	1.25 in 32 mm; 3 positions
Top Shelf Capacity	150 lbs 68 kg
Bottom Shelf Capacity	50 lbs 23 kg

A Side Compartments

Dimensions	11.5H x 19.5 x 14.5 in 29H x 49.5 x 36.75 cm
Adjustable Shelf Capacity	25 lbs 11 kg

B Center Compartment

Dimensions	11.5H x 38.75 x 14 in 29H x 98 x 35.5 cm
Adjustable Shelf Capacity	50 lbs 23 kg

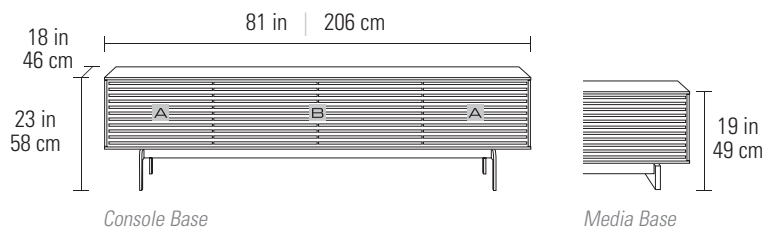

7479 STORAGE CONSOLE + MEDIA CABINET

Recommended TV Size	up to 85"
Dimensions (Console Base)	28.5H x 81 x 18 in 73H x 206 x 46 cm
Dimensions (Media Base)	25H x 81 x 18 in 63H x 206 x 46 cm
Component Capacity	8-12
Number of Adjustable Shelves	3
Adjustable Shelf Increments	1.25 in 32 mm; 5 positions
Top Shelf Capacity	150 lbs 68 kg
Bottom Shelf Capacity	50 lbs 23 kg

A Side Compartments

Dimensions	17H x 19.5 x 14.5 in 43H x 49.5 x 36.75 cm
Adjustable Shelf Capacity	25 lbs 11 kg

B Center Compartment

Dimensions	17H x 37.5 x 14.25 in 43H x 95 x 36 cm
Adjustable Shelf Capacity	50 lbs 23 kg

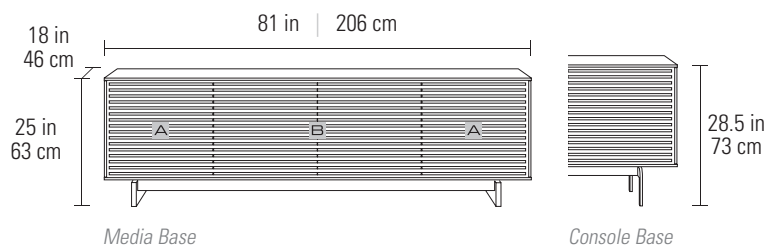

7477 STORAGE CONSOLE + MEDIA CABINET

Recommended TV Size	up to 75"
Dimensions (Console Base)	28.5H x 66 x 18 in 73H x 167 x 46 cm
Dimensions (Media Base)	25H x 66 x 18 in 63H x 167 x 46 cm
Component Capacity	5
Number of Adjustable Shelves	0
Top Shelf Capacity	125 lbs 57 kg
Fixed Shelf Capacity	50 lbs 23 kg
Bottom Shelf Capacity	50 lbs 23 kg



A Top Shelf / Speaker Compartment

Dimensions with Soundbar	8H x 60.75 x 7.25 in 20H x 154 x 18 cm
Dimensions without Soundbar	8.25H x 24.5 x 14.5 in 20H x 62 x 36 cm

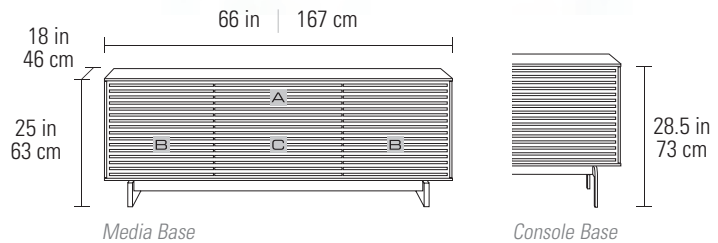

B Side Compartments

Dimensions	8.25H x 19 x 15 in 20.75 x 48 x 38 cm
------------	--

C Center Drawer

Dimensions	6.5H x 23.75 x 12.75 in 16.5H x 60 x 32 cm
Drawer Capacity	25 lbs 11 kg

The unique configuration of Align 7477 features a center media drawer that conceals a full-width shelf that is the perfect home for a soundbar or several electronic components.

For detailed specifications, visit bdiusa.com/align



For product info and detailed specs, visit bdiusa.com/align

FEATURES

- Media or Console Base Option
- Acoustically Transparent Doors
- Cable Management System
- Hidden Wheels (Media base)
- IR-Friendly Doors
- Removable Back Panels
- Soundbar Platform
- TV Safety Strap

EBONIZED ASH
(EBO)

SATIN WHITE
(SW)



Align 7473 with Console Base in Satin White finish



Align 7479 with Media Base in Ebonized Ash finish



CORRIDOR®

BD



CORRIDOR®

DESIGN **MATTHEW WEATHERLY**

This award-winning collection includes an array of storage + media cabinets. Beautifully engineered with a wealth of user-friendly features like adjustable shelves, hidden wheels, and easy-access back panels. The design features a satin-etched glass top surface and louvered doors that allow a speaker's sound or a remote control's signal to pass through.

8172 AUDIO TOWER

- Two adjustable compartments, with dedicated top media storage shelf
- Satin-etched black glass top conceals a power management compartment
- Lower compartment can be arranged for album storage
- Ventilation through door, shelves and back panels allows heat to escape

Recommended TV Size	N/A
Dimensions	44.75H x 22 x 22 in 114H x 56 x 56 cm
Component Capacity	4-6
Number of Adjustable Shelves	3
Adjustable Shelf Increments	1.25 in 32 mm; 3 positions
Base Height	4.75 in 12 cm
Top Shelf Capacity	50 lbs 23 kg
Weight	127 lbs 58 kg

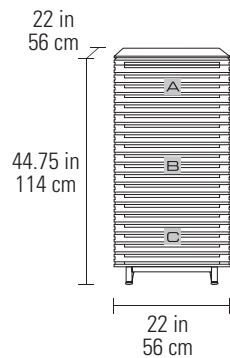

A Media Shelf

Dimensions	5H x 20.25 x 5.75 in 13H x 52 x 15 cm
Shelf Capacity	25 lbs 11 kg

B Upper Component Compartment

Dimensions	17.25H x 20.25 x 20.25 in 44H x 52 x 51.5 cm
Adjustable Shelf Increments	1.25 in 32 mm; 8 positions
Adjustable Shelf Capacity	50 lbs 23 kg
Bottom Shelf Capacity	50 lbs 23 kg

C Lower Component Compartment

Dimensions	13.5H x 20.25 x 14 in 34H x 52 x 35.5 cm
Adjustable Shelf Increments	1.25 in 32 mm; 4 positions
Adjustable Shelf Capacity	50 lbs 23 kg
Bottom Shelf Capacity	100 lbs 45 kg

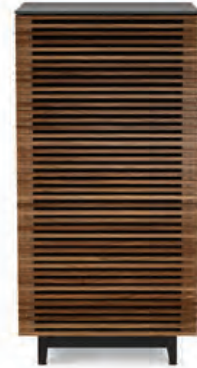

Door can be positioned to open from left or right



The tower's top is the ideal home for a turntable and the lower section can be configured for album storage



Satin-etched glass top conceals a compartment to contain a power strip

8173 LOW MEDIA CABINET

- Low profile design complements use with larger TVs
- Center compartment's shelf accommodates many soundbars
- Side component compartments include an adjustable shelf

Recommended TV Size	up to 85"
Dimensions	21H x 79.25 x 20.25 in 53.5H x 201 x 51 cm
Component Capacity	6-9
Number of Adjustable Shelves	3
Adjustable Shelf Increments	1.25 in 32 mm; 3 positions
Base Height	4.75 in 12 cm
Top Shelf Capacity	175 lbs 80 kg
Weight	208 lbs 94 kg

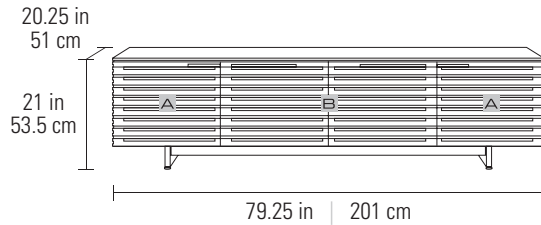

△ Side Compartments

Dimensions	13H x 19 x 18.25 in 33.5H x 48 x 46.5 cm
Adjustable Shelf Capacity	50 lbs 23 kg
Bottom Shelf Capacity	100 lbs 45 kg

▢ Center Compartment

Dimensions	13H x 38 x 15.75 in 33.5H x 97 x 40 cm
Adjustable Shelf Capacity	50 lbs 23 kg
Bottom Shelf Capacity	100 lbs 45 kg



Removable back panels provide easy access to cables and connections



Center compartment accommodates a soundbar up to 38.1 in | 97 cm wide

8175 CORNER MEDIA CABINET

- Top fixed shelf accommodates a soundbar or components
- Lower shelves adjust to accommodate components and media
- For security, 8175 is not available with wheels

Recommended TV Size	up to 55"
Dimensions	25H x 50.25 x 20 in 63H x 128 x 51 cm
Component Capacity	5-8
Number of Adjustable Shelves	3
Adjustable Shelf Increments	1.25 in 32 mm; 4 positions
Base Height	4.25 in 11 cm
Top Shelf Capacity	175 lbs 80 kg
Weight	140 lbs 64 kg

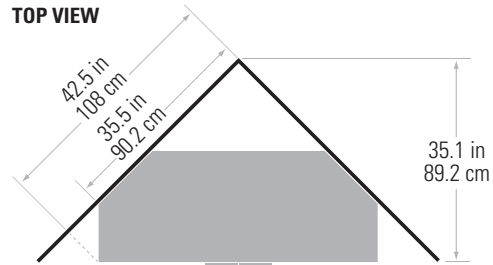
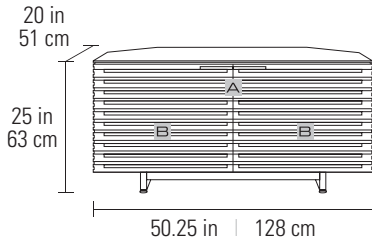

▲ Top Speaker/Component Compartment

Dimensions	
Component Use	6.75H x 17.75-23.75 x 15 in 17.5H x 45.5-60.5 x 38 cm
Speaker Use	6.75H x 48.5 x 8.25 in 17.5H x 123 x 21 cm
Fixed Shelf Capacity	50 lbs 23 kg

▢ Lower Compartments

Dimensions	10H x 15-23.75 x 18.25 in 25.5H x 38.5-60.5 x 46.5 cm
Adjustable Shelf Capacity	50 lbs 23 kg
Bottom Shelf Capacity	75 lbs 34 kg



Tapered panels allow model 8175 to fit neatly into corners

FEATURES

- Acoustically Transparent Doors
- Adjustable Shelves
- Cable Management System
- Hidden Wheels (except 8175)
- IR-Friendly Doors
- Removable Back Panels
- Soundbar Shelf
- TV Safety Strap

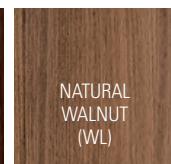
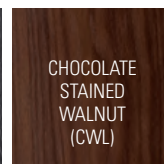
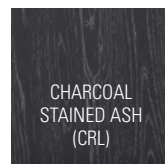

8177 MEDIA CONSOLE

- Cabinet includes a fixed full-width shelf for a soundbar or components
- Center panel pulls out to reveal a media storage drawer

Recommended TV Size	up to 70"
Dimensions	28.25H x 65 x 20.25 in 72H x 166 x 51 cm
Component Capacity	6-9
Adjustable Shelf Increments	N/A
Base Height	8.5 in 21.5 cm
Top Shelf Capacity	150 lbs 69 kg
Weight	204 lbs 93 kg

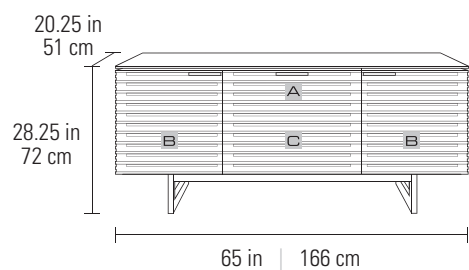

A Top Shelf / Speaker Compartment

Dimensions	
*with Soundbar	8H x 61.5 x 8.25 in 20H x 156.5 x 21 cm
*without Soundbar	8H x 25.5 x 16 in 20H x 65 x 40.5 cm
Bottom Shelf Capacity	75 lbs 34 kg

*WITH SOUNDBAR

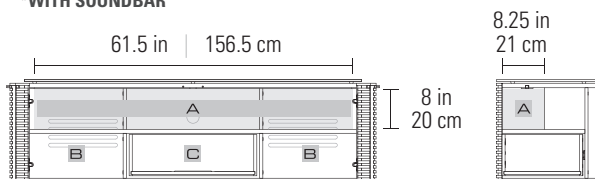

B Side Compartments

Dimensions	8.5H x 17.25 x 18.5 in 22H x 44 x 46.5 cm
Bottom Shelf Capacity	75 lbs 34 kg

**WITHOUT SOUNDBAR

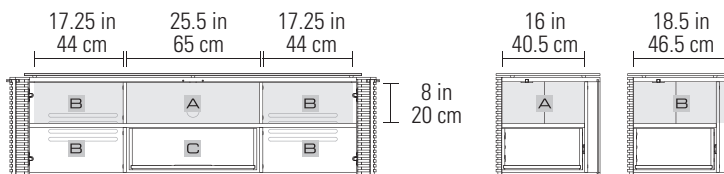

C Center Drawer

Dimensions	7.25H x 23.25 x 14.25 in 18.5H x 59 x 36.5 cm
Drawer Capacity	40 lbs 18 kg



Corridor 8177 features a full-length top shelf for use with a soundbar or components. The center drawer pulls out for easy access to concealed media storage

Optional lower leg kit for Corridor 8177 & 8179. Height of lower legs is 4.75 in | 12 cm, reducing overall height by 3.75 in | 9.5 cm

8179 MEDIA CONSOLE

- Four-door console with three inner compartments
- Center compartment can accommodate a small soundbar
- Side compartments include an adjustable shelf

Recommended TV Size	up to 85"
Dimensions	28.25H x 79.25 x 20.25 in 72H x 201 x 51 cm
Component Capacity	8-12
Number of Adjustable Shelves	3
Adjustable Shelf Increments	1.25 in 32 mm; 7 positions
Base Height	8.5 in 21.5 cm
Top Shelf Capacity	175 lbs 80 kg
Weight	216 lbs 98 kg

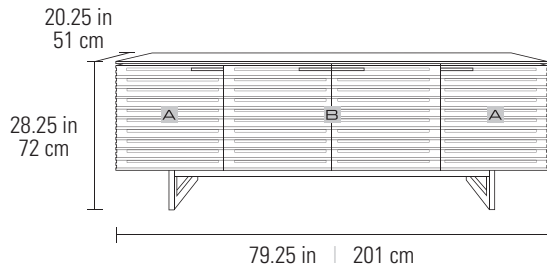

A Side Compartments

Dimensions	17.25H x 19 x 18.25 in 44H x 48 x 46.5 cm
Adjustable Shelf Capacity	50 lbs 23 kg
Bottom Shelf Capacity	100 lbs 45 kg

B Center Compartment

Dimensions	17.25H x 38 x 16 in 44H x 97 x 40.5 cm
Adjustable Shelf Capacity	50 lbs 23 kg
Bottom Shelf Capacity	100 lbs 45 kg



Center doors conceal an adjustable shelf for use with a speaker up to 38.1 in | 97 cm wide



Hidden wheels allow the cabinet to be rolled away from the wall for easy access to the back of components



Optional lower leg kit for Corridor 8177 & 8179. Height of lower legs is 4.75 in | 12 cm, reducing overall height by 3.75 in | 9.5 cm

For product info and detailed specs, visit [bdiusa.com/corridor](https://www.bdiusa.com/corridor)



For the most up-to-date product specifications, visit www.bdiusa.com. Note: Recommended TV size is based on industry average sizes. See manufacturer's specs to ensure proper fit. BDI's products are protected by U.S. patent, international patent, trade dress and/or copyright laws. "Corridor" and BDI are trademarks of Becker Designed Inc. All rights reserved. Refer to current price list or contact BDI for specific model and finish availability. Materials and specifications subject to change without notice. BDI products are packaged with recyclable materials. ©2020, BDI



CORRIDOR® STORAGE

DESIGN **MATTHEW WEATHERLY**

Adding a new level of function, these Corridor cabinets create versatile storage solutions. Each interior compartment includes an adjustable shelf and a lined drawer that can be positioned at the top or bottom of the cabinet, allowing for a customized configuration. Cabinets can be combined end-to-end to create longer systems.

8108 2-DOOR CABINET

Recommended TV Size	up to 55"
Overall Dimensions	30H x 39.5 x 18 in 76H x 102 x 46 cm
Top Shelf Capacity	150 lbs 68 kg
Bottom Shelf Capacity	100 lbs 45 kg
Component Capacity	2-4
Number of Adjustable Shelves	1
Weight	127 lbs 58 kg

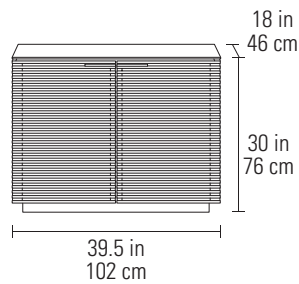

8109 4-DOOR CREDENZA

Recommended TV Size	up to 85"
Overall Dimensions	30H x 79.25 x 18 in 76H x 201 x 46 cm
Top Shelf Capacity	150 lbs 68 kg
Bottom Shelf Capacity	100 lbs 45 kg
Component Capacity	6-8
Number of Adjustable Shelves	2
Weight	244 lbs 111 kg

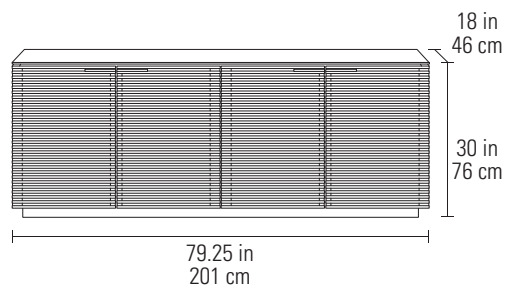

For product info and detailed specs, visit
[bdiusa.com/corridor-storage](https://www.bdiusa.com/corridor-storage)

CHARCOAL
STAINED
ASH
(CRL)

CHOCOLATE
STAINED
WALNUT
(CWL)

NATURAL
WALNUT
(WL)



BDI's products are packaged with recyclable materials. Dimensions, specifications, and availability are subject to change. For current specifications and availability, visit www.bdiusa.com. Listed capacities assume even distribution of weight. BDI's designs are protected by US and international patents, trade dress, and/or copyright laws. "Corridor" and BDI are trademarks of Becker Designed Inc. All rights reserved. ©2024, BDI

CORRIDOR® SV

BDI



CORRIDOR® SV

DESIGN **MATTHEW WEATHERLY**

The Corridor collection takes on a slimmer profile with the Corridor SV. Resting on an elegant base, the slender console is a beautiful addition to a foyer, dining area, or anywhere additional storage is needed.

- Suitable for use with a TV and compact media system
- Open center shelf accommodates electronics or a soundbar
- Fixed back panel includes wire management holes for use with electronics

7128 CONSOLE

Recommended TV Size	up to 60"
Dimensions	30H x 50 x 15.5 in 77H x 128 x 40 cm
Component Capacity	4-6
Number of Adjustable Shelves	0
Base Height	10 in 25.5 cm
Top Shelf Capacity	150 lbs 69 kg
Weight	139 lbs 63 kg

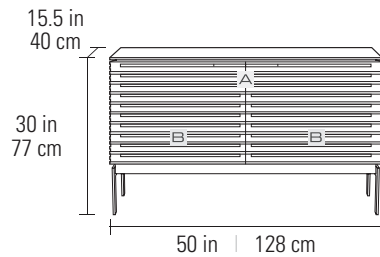

A Top Speaker/Component Compartment

Dimensions	
For Component Use (x2)	7H x 23.75 x 13.5 in 18H x 60.5 x 34.5 cm
For Speaker Use	7H x 48.5 x 7.75 in 18H x 123 x 20 cm
Shelf Capacity	50 lbs 23 kg

B Lower Compartments

Dimensions	9.5H x 23.75 x 13.5 in 24.5H x 60.5 x 34.5 cm
Shelf Capacity	100 lbs 45 kg



7129 CONSOLE

Recommended TV Size	up to 80"
Dimensions	30H x 79 x 15.5 in 77H x 201 x 40 cm
Component Capacity	6–9
Number of Adjustable Shelves	3
Adjustable Shelf Increments	1.25 in 32 mm; 3–7 positions
Base Height	10 in 25.5 cm
Top Shelf Capacity	175 lbs 80 kg
Weight	198 lbs 90 kg

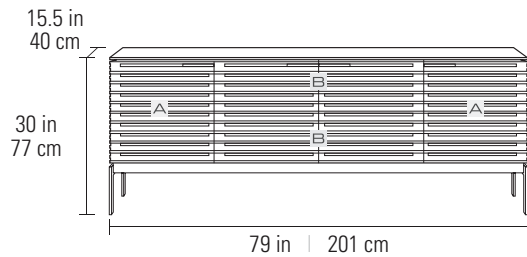

A Side Compartments

Dimensions	17.25H x 19 x 13.5 in 44H x 48 x 34.5 cm
Adjustable Shelf Increments	1.25 in 32 mm, 7 positions
Adjustable Shelf Capacity	50 lbs 23 kg
Bottom Shelf Capacity	100 lbs 45 kg

B Center Compartment

Dimensions	17.25H x 37.75 x 13.5 in 44H x 96 x 34.5 cm
Adjustable Shelf Increments	1.25 in 32 mm, 3 positions
Adjustable Shelf Capacity	50 lbs 23 kg
Bottom Shelf Capacity	100 lbs 45 kg



For product info and detailed specs, visit bdiusa.com/corridor

FEATURES

- Adjustable Shelves (model 7129)
- Adjustable Levelers
- Flow-Through Ventilation
- Cable Routing
- Remote Control Friendly
- Soundbar Shelf
- TV Safety Strap

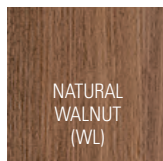
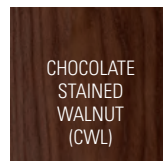
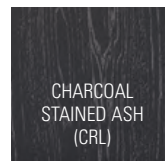



Corridor SV 7128 in Chocolate Stained Walnut finish



Corridor SV 7129 in Natural Walnut finish



For the most up-to-date product specifications, visit www.bdiusa.com. Note: Recommended TV size is based on industry average sizes. See manufacturer's specs to ensure proper fit. BDI's products are protected by U.S. patent, international patent, trade dress and/or copyright laws. "Corridor" and BDI are trademarks of Becker Designed Inc. All rights reserved. Refer to current price list or contact BDI for specific model and finish availability. Materials and specifications subject to change without notice. BDI products are packaged with recyclable materials. ©2020, BDI

CORRIDOR® BAR

BD



CORRIDOR® BAR

DESIGN **MATTHEW WEATHERLY**

5620 COMPACT BAR

The perfect cocktail of style and function, Corridor bar's louvered doors open fully, providing easy access to everything that a stocked bar needs. The cabinet offers racking space for wine bottles and storage for a host of liquor bottles on shelves and doors. A stemware rack keeps wine glasses within easy reach and other shelves provide space for drinkware and supplies.

Dimensions	41H x 36 x 18.5 in 104H x 91 x 47 cm
Top Surface Capacity	75 lbs 35 kg
Door Capacity	20 lbs 9 kg
Drawer Capacity	15 lbs 7 kg
Adjustable Shelf Capacity	15 lbs 7 kg
Number of Adjustable Shelves	1
Adjustable Shelf Spacing	2.5 in 64 mm; (4 positions)
Weight	175 lbs 79 kg

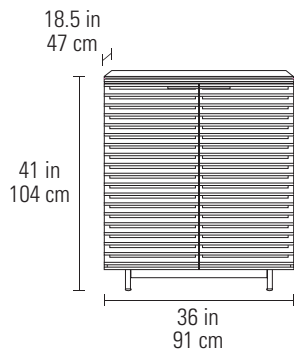

For product info and detailed specs, visit
bdiusa.com/corridor-bar



A wooden stemware rack protects glasses and minimizes vibration



Storage for up to 12 wine bottles



Satin-etched glass top allows for simple clean up



Storage drawer provides a home for utensils, mixers, and other supplies

CHARCOAL
STAINED
ASH
(CRL)

CHOCOLATE
STAINED
WALNUT
(CWL)

NATURAL
WALNUT
(WL)



For the most up-to-date product specifications, visit www.bdiusa.com. BDI's products are protected by US patent, international patent, trade dress, and/or copyright laws. "Corridor" and BDI are trademarks of Becker Designed Inc. All rights reserved. Refer to current price list or contact BDI for specific model and finish availability. Materials and specifications subject to change without notice. BDI products are packaged with recyclable materials. ©2020, BDI



CORRIDOR® SV BAR

DESIGN **MATTHEW WEATHERLY**

Although it features a slim profile, the inspired Corridor SV bar pours on the features. Hidden behind louvered hardwood doors is storage for a complete home bar and glassware. Create the perfect storage solution; the interior can be configured a number of ways allowing you to mix it up whenever you need to.

5621 BAR

Dimensions	44H x 50 x 15.5 in 112H x 127 x 39.5 cm
Top Shelf Capacity	100 lbs 45 kg
Interior Shelves Capacity	50 lbs 22.5 kg
Lower Shelf Capacity	100 lbs 45 kg
Drawer Capacity	25 lbs 11 kg
Drawer Dimensions	2.5H x 18.5 x 10.75 in 6.5H x 47 x 27.5 cm
Adjustable Interior Shelves	2
Shelf Spacing	2.5 ins 64 mm; (4 positions)
Weight	156 lbs 70.75 kg

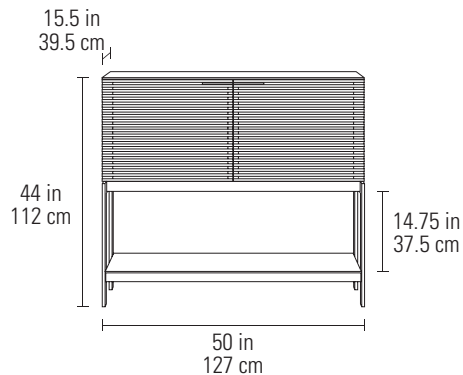

For product info and detailed specs, visit bdiusa.com/corridor-bar



The smooth satin-etched glass top and lower shelf are resistant to scuffs and stains



A versatile lined storage drawer can hold utensils or act as a serving tray for bottles



Stemmed glassware is protected with a felt-lined wooden storage rack to minimize vibration

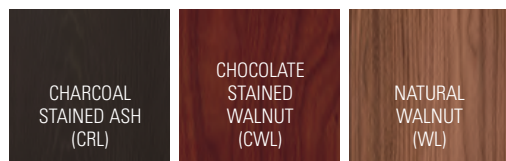

SATIN-ETCHED GLASS

Durable and resistant to scratches, this resilient surface is easy to clean long after the party is over

PRECISION HARDWARE

Soft-close hinges are easily adjustable to keep doors in perfect alignment

STORAGE DRAWER

Used as a utensil drawer with the included liner or as a tray for bottles without, this push-to-open drawer can be positioned on either side of the cabinet

WINE STORAGE

Horizontal storage compartments accommodate wine bottles of varying sizes



STEMWARE RACK

Protecting stemmed glassware, this wooden rack is lined with felt to minimize vibration

ADJUSTABLE SHELVES

Two grey-tinted glass shelves can be positioned anywhere desired throughout the cabinet

LOUVERED DOORS

Hardwood louvered doors provide ventilation and promote airflow

STORE MORE

Whether home to ice buckets or additional bottles, the satin-etched glass shelf provides additional storage within easy reach



COCKTAIL MIXER

The cabinet can be configured a variety of ways, providing an assortment of storage solutions



ELEMENTS®

BD



ELEMENTS®

DESIGN **MATTHEW WEATHERLY**

The Elements collection is a fusion of modern sophistication and timeless design. A BDI classic, inside the cabinet you find thoughtful engineering: adjustable shelves, wire management, removable back panels, and IR-compatibility, all designed to make sure the collection is as functional as it is beautiful.

8703 ROLLING PLINTH BASE 24"H

Recommended TV Size	up to 85"
Overall Dimensions	24H x 82.5 x 20 in 60H x 209 x 51 cm
Top Shelf Capacity	150 lbs 69 kg
Bottom Shelf Capacity	100 lbs 45 kg
Component Capacity	8-12
Number of Adjustable Shelves	3
Weight	196 lbs 89 kg

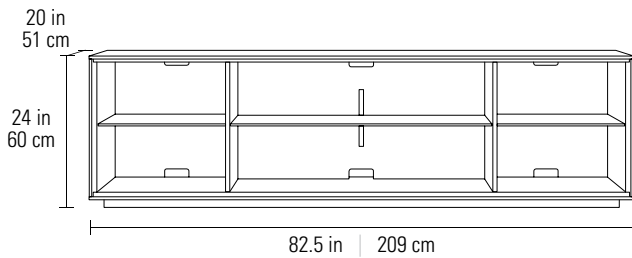

8703-CS-TOK

8709 CONSOLE BASE 30"H

Recommended TV Size	up to 85"
Overall Dimensions	30H x 82.5 x 20 in 76H x 209 x 51 cm
Top Shelf Capacity	150 lbs 68 kg
Bottom Shelf Capacity	100 lbs 45 kg
Component Capacity	8-12
Number of Adjustable Shelves	3
Weight	216 lbs 98 kg

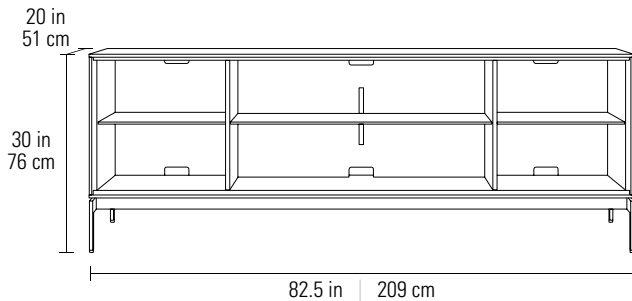

8709-TU-WOK

ELEMENTS®

DOOR DESIGNS

Available in three unique patterns, Elements' doors are crafted with precision laser carving, marrying beauty with functionality. Backed with a mesh and fabric liner, the design of the doors provides acoustic transparency, ventilation, and remote access—a harmonious blend of style and practicality.



Constellation (CS)

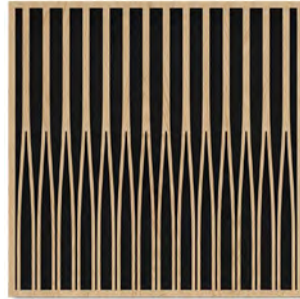

Tune (TU)



Weave (WE)

WOOD FINISHES

Elements is available three distinct wood finishes to complement a variety of settings.



Natural Walnut (WL)



Washed Oak (WOK)



Toasted Oak (TOK)

ELEMENTS®



8709 Console Base Constellation in Washed Oak (8709-CS-WOK)



8703 Rolling Plinth Base Weave in Toasted Oak (8703-WE-TOK)



For product info and detailed specs, visit
[bdiusa.com/elements](https://www.bdiusa.com/elements)

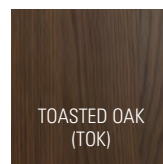

TOASTED OAK
(TOK)

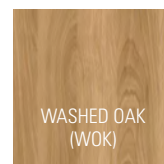

WASHED OAK
(WOK)

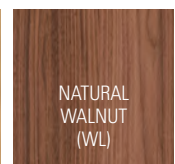

NATURAL
WALNUT
(WL)



BDi's products are packaged with recyclable materials. Dimensions, specifications, and availability are subject to change. For current specifications and availability, visit www.bdiusa.com. Listed capacities assume even distribution of weight. BDI's designs are protected by US and international patents, trade dress, and/or copyright laws. "Elements" and BDI are trademarks of Becker Designed Inc. All rights reserved. ©2024, BDI

MESA™

BDI



MESA™

DESIGN **JASON GUIDRY**

Mesa is an impressive storage solution. Its design contrasts sinuous carved doors with a rectilinear format, mixing in a wealth of versatile storage.

7639 CREDENZA

Dimensions	34H x 79.5 x 18 in 87H x 202 x 46 cm
Top Shelf Capacity	150 lbs 68 kg
Bottom Shelf Capacity	100 lbs 45 kg
Weight	346 lbs 157 kg

Interior Compartments (x2)

Dimensions	22.5H x 38 x 16 in 57H x 97 x 41 cm
Bottom Shelf Capacity	100 lbs 45 kg

Adjustable Shelves (x2)

Adj. Shelf Increments	1.25 in 32 mm; 7 positions
Adj. Shelf Capacity	50 lbs 23 kg

Adjustable Drawers (x2)

Adj. Drawer Dimensions	5H x 33.5 x 12.5 in 12.5H x 86.5 x 32.5 cm
Adj. Drawer Capacity	25 lbs 11 kg

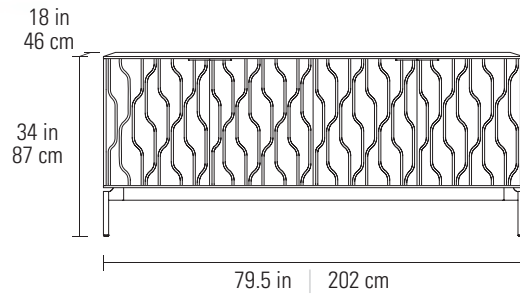

For product info and detailed specs, visit bdiusa.com/mesa



STONE & BRUSHED CARBON

Mesa cabinets are available in two finishes—Stone and Moss—and two base options—Brushed Brass and Brushed Carbon.



STONE & BRUSHED BRASS



MOSS & BRUSHED CARBON



MOSS & BRUSHED BRASS

ADJUSTABLE SHELVES

Shelves rest on threaded inserts, allowing for endless readjustments. Two shelves are included.

WIRE MANAGEMENT

Upper and lower wire management slots allow wires to pass through for use with small electronics.

UTILITY DRAWERS

Two storage drawers can be positioned at the top or bottom of the cabinet, functioning as a storage drawer or serving tray. A removable felt drawer liner keeps contents secure.



INTERIOR CONFIGURATION

Mesa's two drawers can be installed in the top or bottom of either compartment and the adjustable glass shelves can be placed in a multitude of positions.





Stone with Brushed Carbon legs



Moss with Brushed Brass legs



BDI's products are packaged with recyclable materials. Dimensions, specifications, and availability are subject to change. For current specifications and availability, visit www.bdiusa.com. Listed capacities assume even distribution of weight. BDI's designs are protected by US and international patents, trade dress, and/or copyright laws. "Mesa" and BDI are trademarks of Becker Designed Inc. All rights reserved. ©2023, BDI

LINGQ™ STORAGE

BDI



LINQ™

DESIGN **MATTHEW WEATHERLY**

A versatile storage piece with modern appeal, the LINQ Entry Cabinet offers concealed organization in a refined, compact form—perfect for entryways, hallways, or anywhere a little extra storage is needed.

7585 ENTRY CABINET

Overall Dimensions 42H x 36 x 17 in | 107H x 91 x 46 cm
Number of Adjustable Shelves 2
Weight 172 lbs | 78 kg

A Interior Compartment

Dimensions 23.5H x 33.75 x 14.75 in
60H x 86 x 38 cm
Adjustable Shelf Capacity 30 lbs | 13 kg
Bottom Shelf Capacity 75 lbs | 34 kg

B Drawer

Dimensions 6.75H x 32.75 x 12.75 in
18H x 82 x 33 cm
Capacity 40 lbs | 18 kg

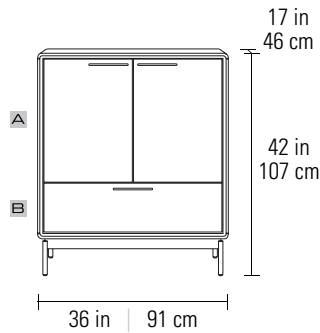

NATURAL
WALNUT
(WL)



For product info and detailed specs, visit
bdiusa.com/linq



BDi's products are packaged with recyclable materials. Dimensions, specifications, and availability are subject to change. For current specifications and availability, visit www.bdiusa.com. Listed capacities assume even distribution of weight. BDI's designs are protected by US and international patents, trade dress, and/or copyright laws. "LINQ" and BDI are trademarks of Becker Designed Inc. All rights reserved. ©2025, BDI



LINGQ™ MEDIA

BD

LINQ™

DESIGN **MATTHEW WEATHERLY**

The LINQ 65" Low Console brings refined modern style and compact performance to the living room. Designed to function beautifully beneath a TV or as a streamlined storage cabinet, it offers versatile organization in a clean, low-profile frame.

7583 65" LOW PROFILE CONSOLE

Recommended TV Size	up to 70"
Overall Dimensions	22H x 65 x 20 in 56H x 165 x 51 cm
Top Panel Capacity	150 lbs 68 kg
Number of Adjustable Shelves	2
Weight	172 lbs 78 kg



Interior Compartments (x2)

Dimensions	13H x 31 x 18 in 33H x 79 x 45 cm
Bottom Shelf Capacity	100 lbs 45 kg

Adjustable Shelves (x2)

Adj. Shelf Increments	1.25 in 32 mm; 7 positions
Adj. Shelf Capacity	30 lbs 13 kg

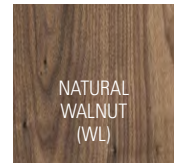
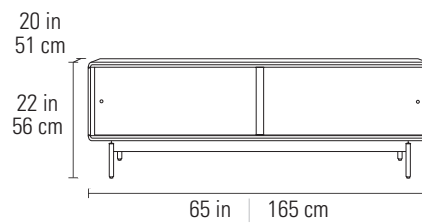

For product info and detailed specs, visit
bdiusa.com/linq



BDI's products are packaged with recyclable materials. Dimensions, specifications, and availability are subject to change. For current specifications and availability, visit www.bdiusa.com. Listed capacities assume even distribution of weight. BDI's designs are protected by US and international patents, trade dress, and/or copyright laws. "LINQ" and BDI are trademarks of Becker Designed Inc. All rights reserved. ©2025, BDI

PROFILE™

BD



PROFILE™

DESIGN **MATTHEW WEATHERLY**

A stunning storage collection, Profile redefines the art of functional design. Housing a complete media center or storing away a wealth of items, each piece stands as a testament to beauty and practicality.

8477 3-DOOR CONSOLE

Recommended TV Size	up to 65"
Overall Dimensions	30H x 61.75 x 20 in 77H x 157 x 51 cm
Top Shelf Capacity	150 lbs 68 kg
Bottom Shelf Capacity	100 lbs 45 kg
Component Capacity	6-9
Number of Adjustable Shelves	4
Weight	211 lbs 96 kg

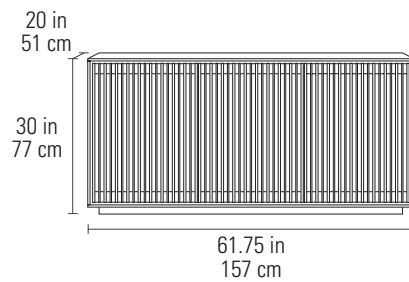

8479 4-DOOR CABINET

Recommended TV Size	up to 85"
Overall Dimensions	23.5H x 81.75 x 20 in 60H x 208 x 51 cm
Top Shelf Capacity	150 lbs 68 kg
Bottom Shelf Capacity	100 lbs 45 kg
Component Capacity	5-8
Number of Adjustable Shelves	3
Weight	203 lbs 92 kg

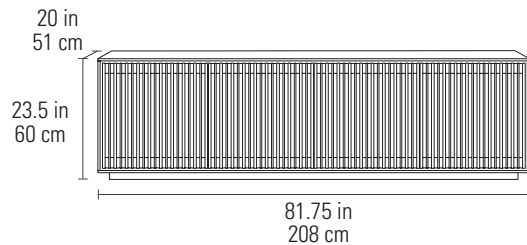

For product info and detailed specs, visit
bdiusa.com/profile

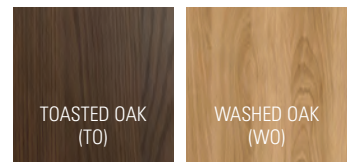

BDI's products are packaged with recyclable materials. Dimensions, specifications, and availability are subject to change. For current specifications and availability, visit www.bdiusa.com. Listed capacities assume even distribution of weight. BDI's designs are protected by US and international patents, trade dress, and/or copyright laws. "Profile" and BDI are trademarks of Becker Designed Inc. All rights reserved. ©2024, BDI



RIPPPLE™

BD

RIPPLE™

DESIGN **JASON GUIDRY**

Ripple's beautifully carved doors bring to mind calm breezes across placid waters, and behind those doors await a wealth of hidden function.

7629 CREDENZA

Dimensions 34H x 79.5 x 18 in
87H x 202 x 46 cm
Top Shelf Capacity 150 lbs | 68 kg
Bottom Shelf Capacity 100 lbs | 45 kg
Weight 346 lbs | 157 kg

Interior Compartments (x2)

Dimensions 22.5H x 38 x 16 in
57H x 97 x 41 cm
Bottom Shelf Capacity 100 lbs | 45 kg

Adjustable Shelves (x2)

Adj. Shelf Increments 1.25 in | 32 mm; 7 positions
Adj. Shelf Capacity 50 lbs | 23 kg

Adjustable Drawers (x2)

Adj. Drawer Dimensions 5H x 33.5 x 12.5 in
12.5H x 86.5 x 32.5 cm
Adj. Drawer Capacity 25 lbs | 11 kg

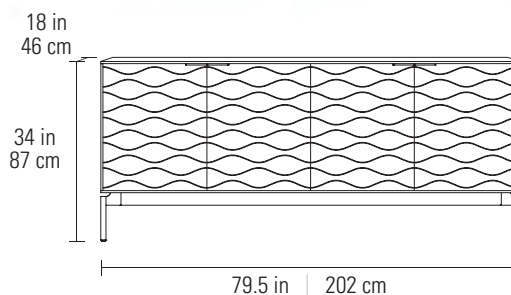

For product info and detailed specs, visit bdiusa.com/ripple



OCEAN & BRUSHED BRASS

Ripple cabinets are available in two finishes—Stone and Ocean—and two base options—Brushed Brass and Brushed Carbon.



OCEAN & BRUSHED CARBON



STONE & BRUSHED BRASS



STONE & BRUSHED CARBON

UTILITY DRAWERS

Two storage drawers can be positioned at the top or bottom of the cabinet, functioning as a storage drawer or serving tray. A removable felt drawer liner keeps contents secure.

ADJUSTABLE SHELVES

Shelves rest on threaded inserts, allowing for endless readjustments. Two shelves are included.

WIRE MANAGEMENT

Upper and lower wire management slots allow wires to pass through for use with small electronics.



INTERIOR CONFIGURATION

Ripple's two drawers can be installed in the top or bottom of either compartment and the adjustable glass shelves can be placed in a multitude of positions.





Ocean with Brushed Carbon legs



Stone with Brushed Brass legs



BDI's products are packaged with recyclable materials. Dimensions, specifications, and availability are subject to change. For current specifications and availability, visit www.bdiusa.com. Listed capacities assume even distribution of weight. BDI's designs are protected by US and international patents, trade dress, and/or copyright laws. "Ripple" and BDI are trademarks of Becker Design Inc. All rights reserved. ©2023, BDI

TANAMI™

BD



TANAMI™

DESIGN **MATTHEW WEATHERLY**

7109 CONSOLE

Recommended TV Size	up to 85"
Dimensions	32H x 79.25 x 18 in 81H x 202 x 46 cm
Component Capacity	6-10
Top Shelf Capacity	175 lbs 79 kg
Weight	176 lbs 80 kg

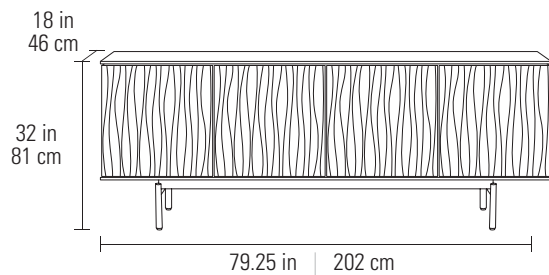

Interior Compartments (x4)

Dimensions	19H x 18.75 x 16.25 in 48H x 48 x 41 cm
Adjustable Shelf Capacity	50 lbs 23 kg
Adjustable Shelf Increments	1.25 in 32 mm; 5 positions
Bottom Shelf Capacity	100 lbs 45 kg

For product info and detailed specs, visit
bdiusa.com/tanami



SATIN BLACK & SATIN BRASS



SATIN WHITE & POLISHED STAINLESS STEEL



GET WIRED

Internal routing channels and provided wire wraps keep cables organized and out of sight.



STRAP IN

The included safety strap secures a TV to the cabinet, helping prevent the possibility of accidental falls.



TOUCH-LATCH DOORS

ADJUSTABLE SHELVES

CABLE MANAGEMENT

FLOW-THROUGH VENTILATION

FLOOR LEVELERS



CURVE APPEAL

Contrasting straight lines with carved, flowing patterns, the Tanami console is a standout. Perfectly at home in an entry or as a buffet, the cabinet's uniquely integrated features also allow it to serve as the foundation for a compact media system.

SATIN BLACK
(B)

SATIN WHITE
(SW)



Satin White with polished Stainless Steel legs



Satin Black with Satin Brass legs





ZIG™

BD

ZIG™

DESIGN **MATTHEW WEATHERLY**

Zig makes a bold impression with its fluted doors and streamlined silhouette. Behind its rhythmic facade lies a flexible interior, ready to adapt to your storage needs.

7649 CREDENZA

Dimensions	34H x 79.5 x 18 in 87H x 202 x 46 cm
Top Shelf Capacity	150 lbs 68 kg
Bottom Shelf Capacity	100 lbs 45 kg
Weight	346 lbs 157 kg

Interior Compartments (x2)

Dimensions	22.5H x 38 x 16 in 57H x 97 x 41 cm
------------	--

Bottom Shelf Capacity	100 lbs 45 kg
-----------------------	-----------------

Adjustable Shelves (x2)

Adj. Shelf Increments	1.25 in 32 mm; 7 positions
-----------------------	------------------------------

Adj. Shelf Capacity	50 lbs 23 kg
---------------------	----------------

Adjustable Drawers (x2)

Adj. Drawer Dimensions	5H x 33.5 x 12.5 in 12.5H x 86.5 x 32.5 cm
------------------------	---

Adj. Drawer Capacity	25 lbs 11 kg
----------------------	----------------

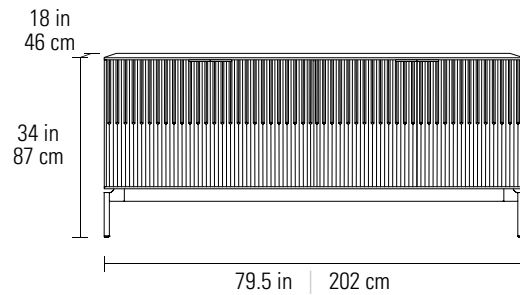

MERLOT & BRUSHED BRASS

Zig cabinets are available in two finishes—Dune and Merlot—and two base options—Brushed Brass and Brushed Carbon.



MERLOT & BRUSHED CARBON



DUNE & BRUSHED BRASS



DUNE & BRUSHED CARBON

ZIG™

UTILITY DRAWERS

Two storage drawers can be positioned at the top or bottom of the cabinet, functioning as a storage drawer or serving tray. A removable felt drawer liner keeps contents secure.

ADJUSTABLE SHELVES

Shelves rest on threaded inserts, allowing for endless readjustments. Two shelves are included.

WIRE MANAGEMENT

Upper and lower wire management slots allow wires to pass through for use with small electronics.



INTERIOR CONFIGURATION

Zig's two drawers can be installed in the top or bottom of either compartment and the adjustable glass shelves can be placed in a multitude of positions.



ZIG™



Dune & Brushed Brass Base



Merlot & Brushed Carbon Base



For product info and detailed specs, visit [bdiusa.com/zig](https://www.bdiusa.com/zig)

DUNE (DU) &
CARBON (CA)

DUNE (DU) &
BRASS (BR)

MERLOT (ML) &
CARBON (CA)

MERLOT (ML) &
BRASS (BR)



BDi's products are packaged with recyclable materials. Dimensions, specifications, and availability are subject to change. For current specifications and availability, visit www.bdiusa.com. Listed capacities assume even distribution of weight. BDi's designs are protected by US and international patents, trade dress, and/or copyright laws. "Zig" and BDi are trademarks of Becker Designed Inc. All rights reserved. ©2025, BDi

Work. Surf. **Inspire.**



BDIUSA.COM

OFFICE

OFFICE

Everyone wants a workplace that is comfortable and inviting, and if it can be beautifully designed and neatly organized, all the better. Whether it's the corner office or the corner of the bedroom, a BDI Office integrates technology and storage to create an organized environment, sure to inspire creativity and productivity.

Full of unique features such as cable management, integrated keyboard drawers, premium surfaces and unique storage solutions, BDI office designs are engineered to create efficient workspaces. Whether creating a small home office or a complete corporate workspace, a BDI office allows you to create the perfect environment for getting down to business.



BOLLO™

BDI



BOLO™

Meet Bolo. It cradles you in soft, durable leather or performance fabric, and its tough steel frame has your back. Plus, it's loaded with plenty of customizable features.

3531 OFFICE CHAIR—LEATHER | 3532 OFFICE CHAIR—FABRIC

Overall Dimensions	49–52H x 28 x 26 in 125–132H x 71 x 66 cm
Headrest	7 positions; 2.4 in 60 mm
Seat Height	17.5–20.5 in 45–52 cm
Seat Depth	17.5 in 45 cm
Seat Width	15–20 in 38–50 cm
Armrest Height	9 in 23 cm
Weight Capacity	300 lbs 136 kg
Weight	48 lbs 28 kg

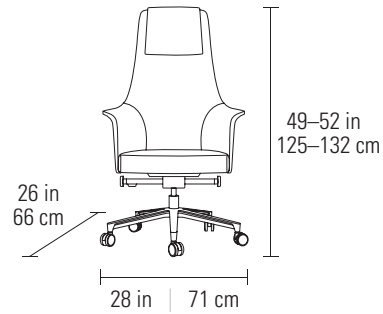

For product info and detailed specs, visit bdiusa.com/bolo

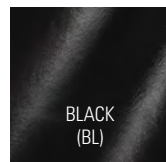

BLACK
(BL)

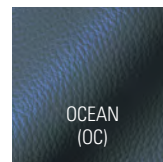

OCEAN
(OC)

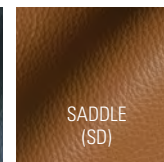

SADDLE
(SD)



OATMEAL
(OT)



BDi's products are packaged with recyclable materials. Dimensions, specifications, and availability are subject to change. For current specifications and availability, visit www.bdiusa.com. Listed capacities assume even distribution of weight. BDI's designs are protected by US and international patents, trade dress, and/or copyright laws. "Bolo" and BDI are trademarks of Becker Designed Inc. All rights reserved. ©2025, BDI



CENTRO™ OFFICE Create an elegant and functional workspace with CENTRO. Providing generous work surfaces and multiple options for file and supply storage, CENTRO can be assembled in a variety of configurations for office spaces large or small. The collection features grey, micro-etched glass tops, white painted oak veneers, and white powder-coated steel details.

CENTRO™ OFFICE

DESIGN **MATTHEW WEATHERLY**

6401 DESK

- Integrated system drawer includes keyboard/mouse tray and storage for rechargeable items.
- Magnetically attached front and back panels tilt or are removable for easy access to concealed wiring. When placed against a wall, the back panel can be left off for direct access to wall outlets.
- A power strip can be attached with the included magnetic mounting kit (power strip not included).

Overall Dimensions (H x W x D) 29 x 66.25 x 26 in | 74 x 168 x 66 cm
Top Capacity 75 lbs | 34 kg
Weight 113 lbs | 51 kg

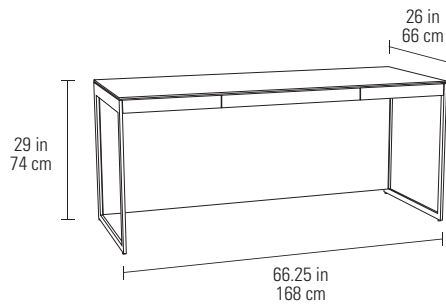

CENTRO Desk 6401 includes a multi-function drawer lined with non-slip material to keep a keyboard, mouse and rechargeable electronics in place.

6402 RETURN

- Micro-etched, grey glass top provides a smooth work surface.
- Can be attached to other CENTRO components with sturdy, steel connections.
- Attaches to CENTRO Desk 6401, 3-Drawer File Cabinet 6414, Lateral File Cabinet 6416, and Multifunction Cabinet 6417.

Overall Dimensions (H x W x D) 29 x 40.25 x 18 in | 74 x 102 x 46 cm
Top Capacity 75 lbs | 34 kg
Weight 38 lbs | 17 kg

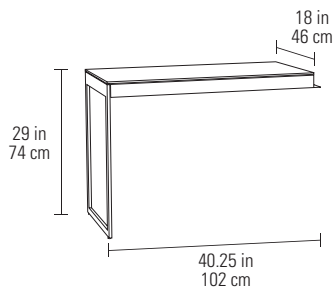

6407 MOBILE FILE PEDESTAL

- File pedestal with locking storage drawer and letter or legal file drawers.
- Top storage tray pulls out for easy access to regularly used items.
- Pedestal rest on locking casters.
- Designed to fit neatly under the CENTRO Desk 6401.

Overall Dimensions (H x W x D) 23 x 15.25 x 21 in | 59 x 39 x 54 cm
Weight 60 lbs | 27 kg

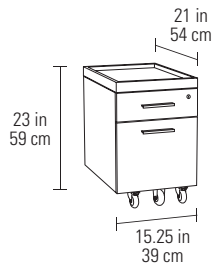

Mobile File Pedestal 6407's top tray slides out for easy access to everyday supplies.

6414 3-DRAWER FILE CABINET

- Micro-etched glass top beautifully extends the workspace.
- Integrated lock keeps contents secure.
- Includes two storage drawers and a file drawer for hanging letter or legal-sized folders.

Overall Dimensions (H x W x D) 29 x 15.5 x 18 in | 74 x 39 x 46 cm
Weight 85 lbs | 39 kg

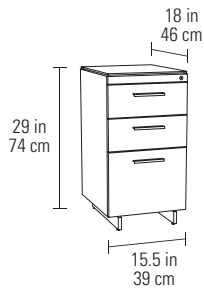

6416 LATERAL FILE CABINET

- Locking file cabinet offers secure storage for legal and/or letter-sized hanging files.
- For safety, drawers include interlock anti-tip hardware, allowing only one drawer to open at a time. A rear counterweight provides stability.

Overall Dimensions (H x W x D) 29 x 35 x 18 in | 74 x 89 x 46 cm

File Drawer Capacity 65 lbs | 29.5 kg

Weight 152 lbs | 69 kg

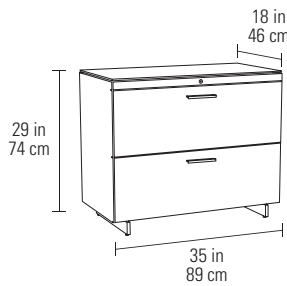

File drawers can accommodate hanging letter and/or legal files.

6417 MULTIFUNCTION CABINET

- Perfect all-purpose piece for a small office.
- Integrated lock keeps contents secure.
- Open compartment includes a pullout printer tray and an adjustable shelf.
- Includes two storage drawers for supplies and a file drawer for legal and/or letter-sized hanging files.

Overall Dimensions (H x W x D) 29 x 35 x 18 in | 74 x 89 x 46 cm

Printer Compartment (H x W x D) 10.7 x 20 x 17.2 in | 27.3 x 50.8 x 43.9 cm

File Drawer Capacity 65 lbs | 29.5 kg

Weight 141 lbs | 64 kg

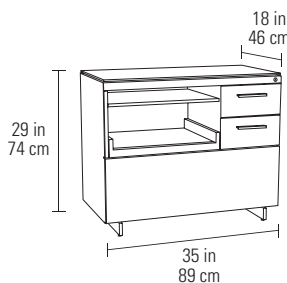



CENTRO Desk 6401 with Mobile File Pedestal 6407 and Multifunction Cabinet 6417.



CENTRO Return 6402 can attach to any of the cabinets to create a compact workstation.



Create a shared workspace by adding a CENTRO Return 6402 to either side of a cabinet.



The CENTRO Return 6402 attaches to the Desk 6401 and Cabinets 6414, 6416 and 6417 to create a workspace of any size.



CENTRO Office Collection



SATIN WHITE/
GREY GLASS TOP

For product info and detailed specs, visit
bdiusa.com/centro



For the most up-to-date product specifications, visit www.bdiusa.com. BDI's products are protected by US patent, international patent, trade dress, and/or copyright laws. "Centro" and BDI are trademarks of Becker Designed Inc. All rights reserved. Refer to current price list or contact BDI for specific model and finish availability. Materials and specifications subject to change without notice. BDI products are packaged with recyclable materials. ©2015, BDI

CENTRO™ LIFT DESKS

BDI



CENTRO™ LIFT DESKS

DESIGN **MATTHEW WEATHERLY**

The Centro Lift Desks provide a versatile work space at the touch of a button. Whether sitting, standing, or somewhere in between, these height-adjustable desks can be positioned for maximum comfort and work efficiency.

- Grey, micro-etched top provides a smooth work surface, accented with a satin white beveled panel beneath it
- Digital, programmable keypad can be installed on left or right of desk
- Optional keyboard storage drawer can be fitted to either desk and is lined with nonslip material
- Cable management system keeps wiring organized and out-of-sight
- A power strip can be mounted under the desk to minimize excess wires (power strip not included)



6451-2 LIFT DESK
(60" x 24" DESKTOP)

Dimensions 24.75–49.75H x 60 x 24 in
63–126H x 153 x 61 cm
Capacity 150 lbs | 68 kg
Weight 127 lbs | 58 kg

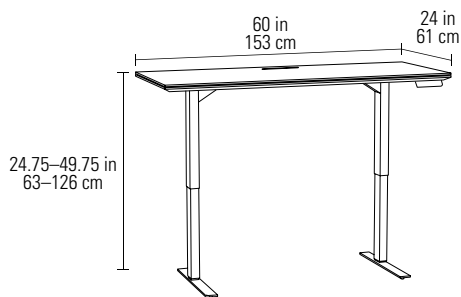

6452-2 LIFT DESK
(66" x 30" DESKTOP)

Dimensions 24.75–49.75H x 66 x 30 in
63–126H x 168 x 76 cm
Capacity 150 lbs | 68 kg
Weight 156 lbs | 71 kg

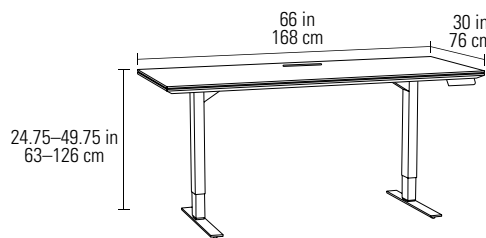

6459-2 KEYBOARD / STORAGE DRAWER

Dimensions 2.25H x 27.75 x 11 in
5.5H x 70.5 x 27.5 cm
Weight 10 lbs | 4.5 kg

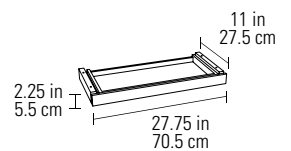

For product info and detailed specs, visit
bdiusa.com/centro





PROGRAMMABLE DIGITAL KEYPAD



CABLE MANAGEMENT SYSTEM



PARTNERS WITH OTHER CENTRO COMPONENTS



CABLE MANAGEMENT LEDGE



COMPATIBLE WITH THIRD-PARTY MONITOR ARMS



OPTIONAL DRAWER CAN BE ADDED TO EITHER DESK



For the most up-to-date product specifications, visit www.bdiusa.com. BDI's products are protected by US patent, international patent, trade dress, and/or copyright laws. "Centro" and BDI are trademarks of Becker Designed Inc. All rights reserved. Refer to current price list or contact BDI for specific model and finish availability. Materials and specifications subject to change without notice. BDI products are packaged with recyclable materials. ©2020, BDI

CIRCA™

BDI



CIRCA™

Circa is a sculptural, comfort-first work chair designed to feel as good as it looks. With supportive ergonomics and effortless movement, it avoids the visual weight of a traditional task chair.

3581 OFFICE CHAIR—LEATHER | 3582 OFFICE CHAIR—FABRIC

Overall Dimensions	31.5–34H x 23.5 x 23 in 80–86H x 59 x 58 cm
Seat Height	17.5–20 in 45–51 cm
Seat Depth	22.5 in 57 cm
Seat Width	23 in 59 cm
Armrest Height	9 in 23 cm
Weight Capacity	300 lbs 136 kg
Weight	27 lbs 12 kg



Leather models feature a semi-aniline leather seat with a durable, color-matched outer shell, while performance fabric models are fully upholstered for a softer, more relaxed presence.



For product info and detailed specs, visit bdiusa.com/circa

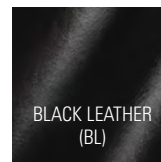

BLACK LEATHER
(BL)

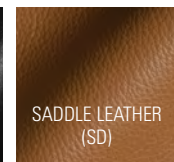

SADDLE LEATHER
(SD)



OATMEAL FABRIC
(OT)



BDi's products are packaged with recyclable materials. Dimensions, specifications, and availability are subject to change. For current specifications and availability, visit www.bdiusa.com. Listed capacities assume even distribution of weight. BDi's designs are protected by US and international patents, trade dress, and/or copyright laws. "Circa" and BDi are trademarks of Becker Designed Inc. All rights reserved. ©2026, BDi



CODDA™

BD

CODA™

DESIGN **CLAUDIO BELLINI**

While many office chairs may seem more suited to the confines of the conference room than the comforts of home, Coda is the best of both worlds—a high-performing, fully customizable task chair with a design that doesn't compromise on style. Constructed with premium materials and rigorously-tested hardware, Coda is BIFMA certified, suitable for any application.

Dimensions 44.5–51H x 18.5 x 23–25 in
113–130H x 47 x 58–63 cm

Back Height 23.5 in | 60 cm
Seat Height 17–19.5 in | 43.5–50 cm
Seat Width 19.5 in | 50 cm
Seat Depth 17–19 in | 43–48 cm
Armrest Height 7.5–10.25 in | 19–26 cm
Max User Weight 300 lbs | 136 kg
Weight 42 lbs | 19 kg

5-year Limited Warranty

For product info and detailed specs, visit
bdiusa.com/coda



3521 BLACK/GREY & BLACK BASE



3522 OYSTER/GREY & ALUMINUM BASE



COMFORT HEADREST

The wide, cushioned headrest adjusts in height, locking in ten different positions (3.5" | 9 cm range).

HIGH PERFORMANCE FABRIC

Rigorously tested, durable, and easy to clean, the chair's unique poly/nylon blend adds strength and resiliency.

ADJUSTABLE ARMRESTS

Armrests adjust in every direction—up/down, in/out, front/back—to provide tailored alignment and ergonomic support for arms and wrists.

ADJUSTABLE SEAT HEIGHT

The gentle pull of a lever adjusts the seat to the perfect height.

TILT TENSION CONTROL

Fine-tune the feel of your chair by adjusting the amount of force needed to recline.



FLOW-THROUGH COMFORT

Breathable fabric covers the ventilated backrest, evenly distributing weight and promoting airflow.

LUMBAR SUPPORT

Adjust placement on the spine to one of six positions to achieve the perfect balance of pressure and support.

ADJUSTABLE SEAT DEPTH

The seat glides forwards or backwards to ensure a custom fit, regardless of user's height.

SYNCHRO-TILT

The seat and back panel tilt in perfect harmony, keeping legs straight while reclining. The tilt feature locks into one of four recline positions.

BLACK/GREY
(BGB)

OYSTER/GREY
(OGA)



Coda 3522 | Oyster/Grey
& Aluminum Base



Coda 3521 | Black/Grey & Black Base



BDI's products are packaged with recyclable materials. Dimensions, specifications, and availability are subject to change. For current specifications and availability, visit www.bdiusa.com. Listed capacities assume even distribution of weight. BDI's designs are protected by US and international patents, trade dress, and/or copyright laws. "Coda" and BDI are trademarks of Becker Designed Inc. All rights reserved. ©2023, BDI



CORRIDOR® OFFICE

BDI

CORRIDOR® OFFICE

DESIGN **MATTHEW WEATHERLY**



6521 DESK

- Satin-etched glass top provides a smooth, glare-free work surface
- Includes a center keyboard drawer and two side storage drawers
- Recessed modesty panel allows for cross-desk collaboration
- Wire management tray keeps cables and a power strip organized

Dimensions 29.75H x 67.75 x 32.25 in | 76H x 172 x 82 cm
Weight 183 lbs | 83 kg

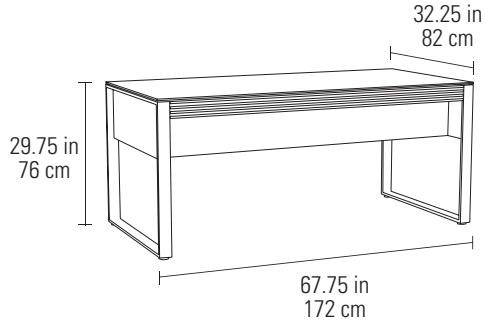

Integrated keyboard drawer and side storage drawers are lined with nonslip material to keep contents in place



6507 MOBILE FILE PEDESTAL

- File pedestal with two storage drawers and a hanging file drawer
- All drawers are secured with one master lock
- File drawer can accommodate letter or legal-sized hanging folders
- Locking casters secure the pedestal in place when desired

Dimensions 25.25H x 15.5 x 21.5 in | 64H x 39 x 54.5 cm
File Drawer Capacity 40 lbs | 18 kg
Weight 71 lbs | 32 kg

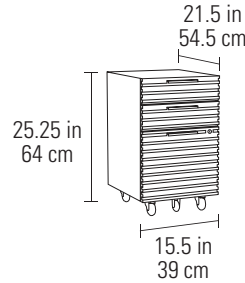

Mobile File Cabinet slides neatly underneath the Desk for easy access to supplies and files



6520 MULTIFUNCTION CABINET

- Includes a pullout printer tray, storage shelf, and an adjustable supply cabinet
- Two supply drawers and a file drawer are secured with one lock
- Lateral file drawer can accommodate letter and/or legal-sized hanging folders

Dimensions	30H x 47.75 x 18 in 76.5H x 121 x 46 cm
Printer Compartment	9.5H x 21.5 x 16 in 24H x 55 x 40.5 cm
Lateral File Drawer Capacity	50 lbs 22.5 kg
Printer Tray Capacity	30 lbs 13.5 kg
Adjustable Shelf Capacity	50 lbs 22.5 kg
Weight	202 lbs 92 kg

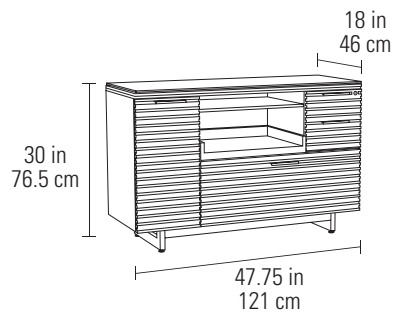

6529 CREDENZA

- Includes a storage cabinet and supply and hanging file drawers
- The supply and file drawers are secured with one lock
- Louvered doors conceal a compartment with an adjustable shelf
- File drawer can accommodate letter or legal-sized hanging folders

Dimensions	30H x 70 x 18 in 76.5H x 178 x 46 cm
Storage Drawer Capacity	25 lbs 11 kg
Lateral File Drawer Capacity	50 lbs 22.5 kg
Adjustable Shelf Capacity	50 lbs 22.5 kg
Weight	225 lbs 102 kg

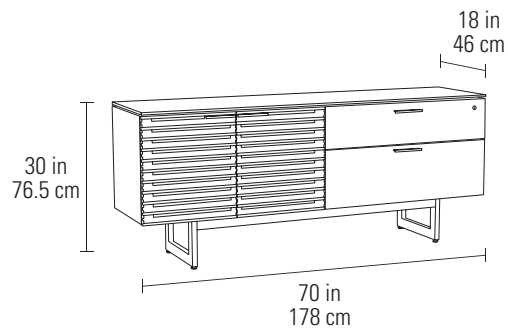

For product info and detailed specs, visit bdiusa.com/corridor-office



Locking file drawers accommodate hanging letter and/or legal files with adjustable hanging rails

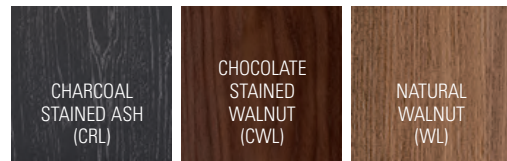



For the most up-to-date product specifications, visit www.bdiusa.com. BDI's products are protected by US patent, international patent, trade dress, and/or copyright laws. "Corridor" and BDI are trademarks of Becker Designed Inc. All rights reserved. Refer to current price list or contact BDI for specific model and finish availability. Materials and specifications subject to change without notice. BDI products are packaged with recyclable materials. ©2020, BDI

CORRIDOR® DESK

BD



CORRIDOR® DESK

DESIGN **MATTHEW WEATHERLY**

6501 DESK

A welcome addition to the popular Corridor Office family, the 6501 Desk is ideally-sized for home and small office use.

Dimensions 30H x 60 x 26 in | 77H x 153 x 66 cm
Weight 137 lbs | 62 kg

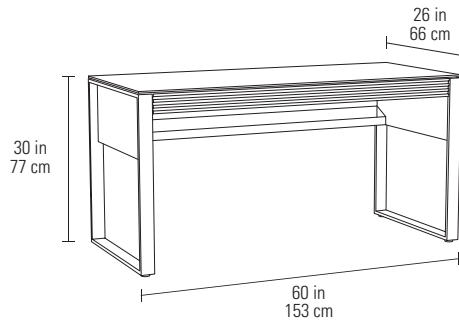

For product info and detailed specs, visit
bdiusa.com/corridor-office



The drawer's face flips down to reveal a fully-lined keyboard drawer, serving as a mousepad and keeping contents secure. Two side compartments keep smaller items from rolling around.



6501 Desk pairs perfectly with the Corridor Mobile File Pedestal and Multifunction Cabinet



A concealed wire management shelf serves as the power center for the desk (power strip not included).

CHARCOAL
STAINED ASH
(CRL)

CHOCOLATE
STAINED
WALNUT
(CWL)

NATURAL
WALNUT
(WL)



BDI's products are packaged with recyclable materials. Dimensions, specifications, and availability are subject to change. For current specifications and availability, visit www.bdiusa.com. Listed capacities assume even distribution of weight. BDI's designs are protected by US and international patents, trade dress, and/or copyright laws. "Corridor" and BDI are trademarks of Becker Designed Inc. All rights reserved. ©2023, BDI

CORRIDOR® L-DESK

BD



CORRIDOR® L-DESK

DESIGN **MATTHEW WEATHERLY**

6531 L-DESK

- Can be assembled with the desk on left or right
- Lined flip-down keyboard drawer
- Modesty panel adds privacy and conceals wiring
- Includes two storage drawers and a lateral file drawer
- All cabinet drawers are secured with one lock

Desk	29H x 70 x 32 in 74H x 178 x 81.5 cm
Cabinet	25.5H x 74 x 20 in 65H x 188 x 51 cm
Printer Compartment	18.5H x 17.25 x 16 in 47H x 44 x 40.5 cm
Max. Desk Capacity	125 lbs 57 kg
Max. Cabinet Capacity	150 lbs 68 kg
Desk Weight	115 lbs 53 kg
Cabinet Weight	245 lbs 111 kg

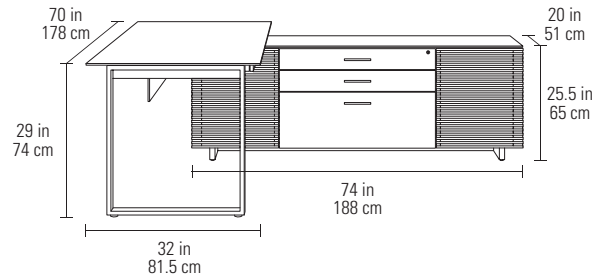

For product info and detailed specs, visit bdiusa.com/corridor-office

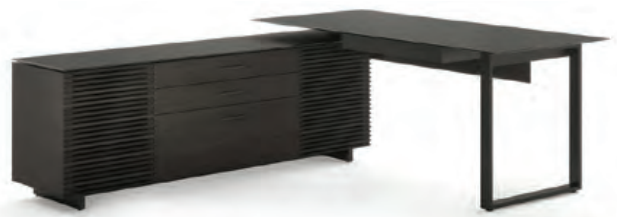

Locking file drawer holds letter and/or legal hanging files



The cabinet's finished back panel allows it to float beautifully in any space.



A push-to-open tray can be positioned in either side cabinet, suitable for use with an oversized printer or all-in-one

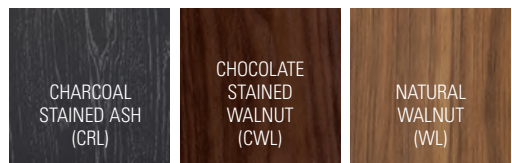

For the most up-to-date product specifications, visit www.bdiusa.com. BDI's products are protected by US patent, international patent, trade dress, and/or copyright laws. "Corridor" and BDI are trademarks of Becker Designed Inc. All rights reserved. Refer to current price list or contact BDI for specific model and finish availability. Materials and specifications subject to change without notice. BDI products are packaged with recyclable materials. ©2021, BDI



LINEA™ OFFICE

BDI

LINEA™ OFFICE

DESIGN **MATTHEW WEATHERLY**



6221 DESK

- Full-width lined keyboard drawer
- Easy-access front and back panels
- Power management tray
- Integrated wire management

Dimensions 29H x 54 x 23.75 in
74H x 137 x 60 cm
Top Capacity 125 lbs | 56.5 kg
Weight 106 lbs | 48 kg

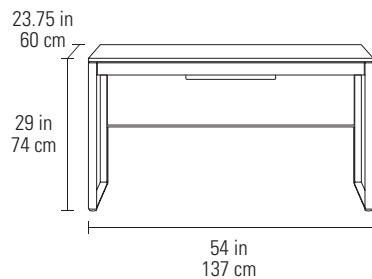

The desk's easy-access panels conceal wiring, a flip-down tray serves as the power hub of the desk (power strip not included)



6222 CONSOLE DESK

- Slim profile suits many applications
- Suitable for use with laptop or desktop computers
- Full-width lined keyboard drawer

Dimensions 29H x 47.5 x 18 in
74H x 121 x 46 cm
Top Capacity 125 lbs | 56.5 kg
Weight 68.5 lbs | 31 kg

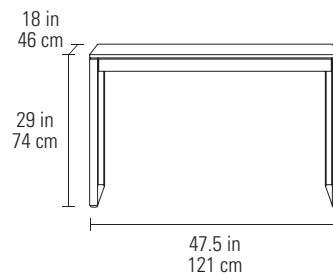

The Console's slim profile makes it suitable for many applications, and is compatible with Mobile File 6227

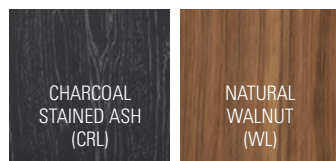



6227 MOBILE FILE

- Top supply drawer
- File drawer for letter/legal file folders
- Both drawers are secured with one lock
- Locking casters

Dimensions 22H x 15.5 x 18 in
56H x 39 x 46 cm
File Drawer Capacity 40 lbs | 18 kg
Weight 51 lbs | 23 kg

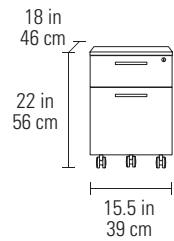

Lower hanging file drawer for letter or legal sized files



6220 MULTIFUNCTION CABINET

- Storage drawer and lateral file drawer that can accommodate letter and/or legal hanging file folders
- Both drawers are secured with one lock
- Removable access panel behind printer compartment may be left off for oversized printers
- Adjustable storage shelf

Dimensions 29H x 56.25 x 18 in | 74H x 142.5 x 46 cm
Printer Compartment 16.75H x 17.25 x 16 in | 42.5H x 44 x 40 cm
Lateral File Drawer Capacity 60 lbs | 27 kg
Printer Tray Capacity 25 lbs | 11 kg
Weight 150 lbs | 68 kg

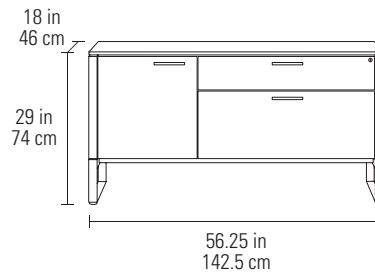

Cabinet door conceals a push-to-open printer tray, suitable for use with larger printers or all-in-ones



Console 6222 pairs well with the Linea Shelf



Desk 6221 and Mobile File 6227



LINEA™ SHELVES

BD



Providing a combination of enclosed storage and open display space, Linea Shelving is a versatile collection that can be used to create wall systems of practically any size. Use a single shelf on its own, select from a preconfigured wall system, or create larger systems by adding shelving sections as needed.



LINEA™ SHELVES

DESIGN **MATTHEW WEATHERLY**

Use a single shelf on its own, select from a preconfigured system, or combine multiple shelves to create a custom Linea wall. Learn more by viewing the Linea Shelving section of this catalog.



5801 SINGLE SHELF
W 18.25 in | 46 cm



5802 DOUBLE SHELF
W 33 in | 83.5 cm



SYSTEM 580012
W 49.75 in | 126 cm



SYSTEM 580022
W 64.5 in | 163.5 cm



SYSTEM 580121
W 66.25 in | 168 cm



SYSTEM 580212
W 81 in | 205.5 cm



SYSTEM 580222
W 96 in | 243.5 cm

Height: 83.75 in | 213 cm
Depth: 14 in | 36 cm

For product info and detailed specs, visit
bdiusa.com/linea

CHARCOAL
STAINED ASH
(CRL)

NATURAL
WALNUT
(WL)

SATIN WHITE
(SW)



BDi's products are packaged with recyclable materials. Dimensions, specifications, and availability are subject to change. For current specifications and availability, visit www.bdiusa.com. Listed capacities assume even distribution of weight. BDI's designs are protected by US and international patents, trade dress, and/or copyright laws. "Linea" and BDI are trademarks of Becker Designed Inc. All rights reserved. ©2022, BDI

LINQ™ OFFICE

BD



LINQ™ OFFICE

DESIGN **MATTHEW WEATHERLY**

Changing the notion of what an executive office can be, this collection is complete with user-friendly features and luxury touches. Intelligently combining natural walnut hardwoods and veneers, the LINQ collection provides a solid foundation for every workday.

6821 EXECUTIVE DESK

Overall Dimensions	29H x 70 x 32 in 74H x 178 x 82 cm
Top Capacity	150 lbs 68 kg
Storage Drawer Capacity	25 lbs 11 kg
File Drawer Capacity	50 lbs 23 kg
Keyboard Drawer Capacity	25 lbs 11 kg
Weight	263 lbs 120 kg

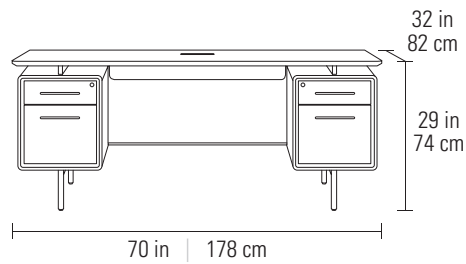

6829 CREDENZA

Overall Dimensions	29H x 70 x 20 in 74H x 178 x 51 cm
Top Capacity	150 lbs 68 kg
Storage Drawer Capacity	30 lbs 14 kg
Lateral File Drawer Capacity	50 lbs 23 kg
Adjustable Shelf Capacity	30 lbs 14 kg
Printer Tray Capacity	30 lbs 14 kg
Weight	213 lbs 97 kg

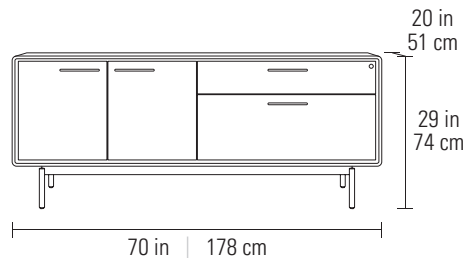

For product info and detailed specs, visit [bdiusa.com/linq-office](https://www.bdiusa.com/linq-office)

NATURAL
WALNUT
(WL)



BDi's products are packaged with recyclable materials. Dimensions, specifications, and availability are subject to change. For current specifications and availability, visit www.bdiusa.com. Listed capacities assume even distribution of weight. BDI's designs are protected by US and international patents, trade dress, and/or copyright laws. "LINQ" and BDI are trademarks of Becker Designed Inc. All rights reserved. ©2024, BDI

LUMMA™ DESKS

BD



LUMA™ LIFT DESKS

DESIGN **BDI DESIGN STUDIO**

Sleek and smart, Luma desks bring clarity to your workspace—whether you prefer a lift or stationary base. With softly beveled edges, satin-etched glass surfaces, and support for thoughtful accessories, each desk is engineered for everyday comfort and long-term performance.

- Satin-etched glass tops that resist glare and fingerprints
- Softly beveled edges for ergonomic comfort
- Available in both height-adjustable and fixed-height formats
- Full-size and compact footprint options
- Integrated cable routing and optional add-ons for a tailored setup



6761 LIFT DESK (48"X24" DESKTOP)

Overall Dimensions 27–44.5H x 44 x 24 in | 69–113H x 121 x 60 cm
Weight Capacity 100 lbs | 45 kg
Weight 107 lbs | 49 kg

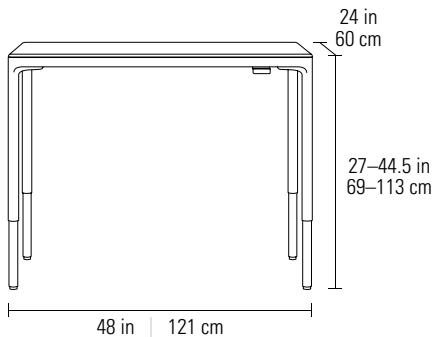

6762 LIFT DESK (66"X28" DESKTOP)

Overall Dimensions 27–44.5H x 66 x 28 in | 69–113H x 168 x 71 cm
Weight Capacity 100 lbs | 45 kg
Weight 144 lbs | 65 kg

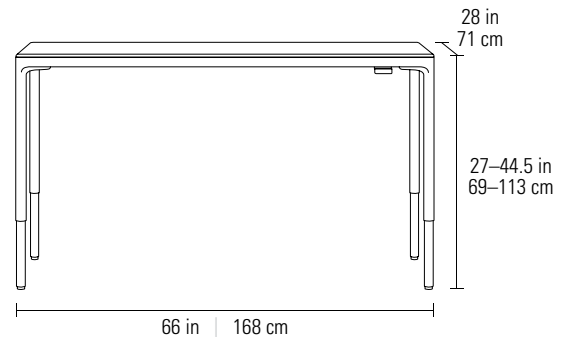

PROGRAMMABLE DIGITAL HANDSET

Lift desks have a digital & programmable control paddle that can be mounted on the left or right side of the desk



UNIQUE 4-LEG LIFT SYSTEM

Lift desks feature a smooth four-leg lift system



POWER STRIP

Lift desks include a power strip

LUMA™ STATIONARY DESKS



6761S STATIONARY DESK (48"X24" DESKTOP)

Overall Dimensions 29H x 48 x 24 in | 74H x 121 x 60 cm
Weight Capacity 100 lbs | 45 kg
Weight 90 lbs | 41 kg

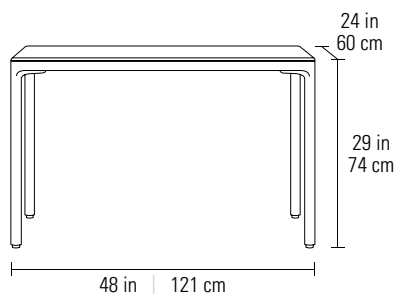

6762S STATIONARY DESK (66"X28" DESKTOP)

Overall Dimensions 29H x 66 x 28 in | 74H x 168 x 71 cm
Weight Capacity 100 lbs | 45 kg
Weight 127 lbs | 58 kg



LUMA™ ACCESSORIES

Luma's optional accessories let you fine-tune your workspace for comfort and organization. The keyboard storage drawer keeps everyday essentials within reach, while the back panel enhances privacy and manages cables.

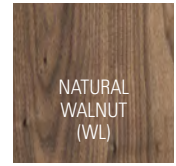

ADJUSTABLE BACK PANEL

- Small is for 48"x24" Luma Desks; large is for 66"x28" Luma Desks
- Can be mounted at 4 different heights to serve as a partition or a modesty panel
- Include an integrated wire management trough to keep cables and small accessories organized

6766 SMALL ADJUSTABLE BACK PANEL

Overall Dimensions 14H x 38.5 x 3.5 in | 36H x 97 x 9 cm



6767 LARGE ADJUSTABLE PANEL

Overall Dimensions 14H x 57 x 3.5 in | 36H x 144 x 9 cm



6769 KEYBOARD / STORAGE DRAWER

- Can be mounted in multiple positions depending on desk configuration
- Lined with nonslip materials that also serves as a mousepad
- Side compartments keep smaller items close at hand

Overall Dimensions 4H x 31 x 15.25 in | 10H x 79 x 38 cm
Interior Dimensions 1.75H x 24.5 x 13.5 in | 4H x 63 x 34 cm

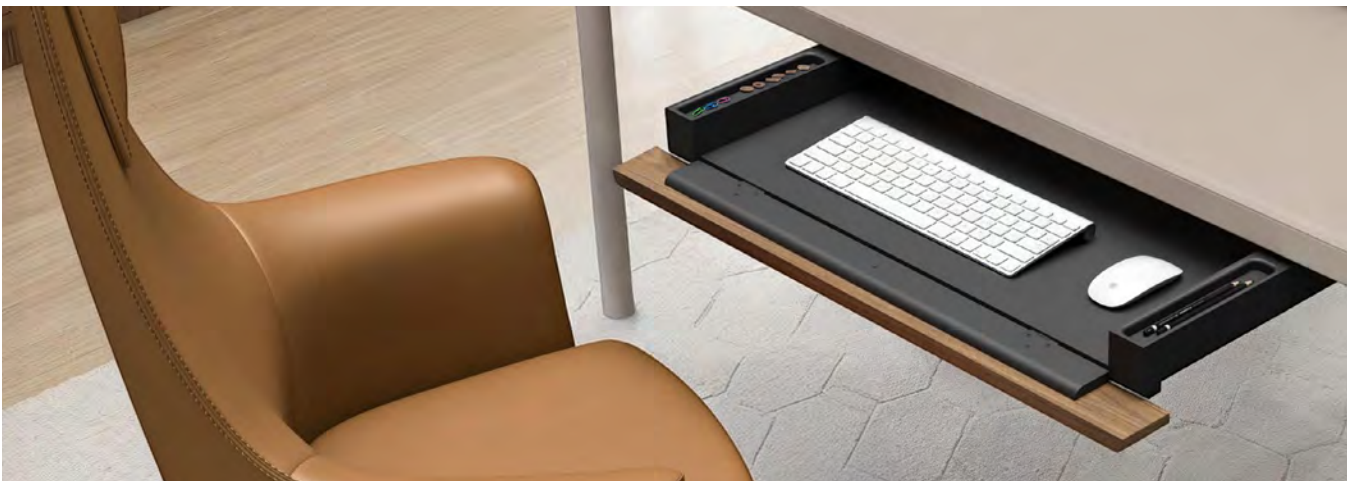

LUMA™ DESKS



For product info and detailed specs, visit
bdiusa.com/luma



BDI's products are packaged with recyclable materials. Dimensions, specifications, and availability are subject to change. For current specifications and availability, visit www.bdiusa.com. Listed capacities assume even distribution of weight. BDI's designs are protected by US and international patents, trade dress, and/or copyright laws. "Luma" and BDI are trademarks of Becker Designed Inc. All rights reserved. ©2025, BDI



LUMA™ STORAGE

BDI

LUMA™ STORAGE

DESIGN **BDI DESIGN STUDIO**

Luma's storage solutions are designed to keep essentials organized and within reach, whether used in a workspace, living area, or beyond. The file pedestal and multifunction cabinet feature soft, curved edges and a modern design that pairs seamlessly with Luma desks—or stands beautifully on its own.

6727 FILE PEDESTAL

- Sliding top shelf
- Supply drawer
- Letter/legal file storage
- Locking drawers
- Finished on all sides

Overall Dimensions 24.5H x 16 x 21.5 in | 63H x 40 x 54 cm
Weight Capacity 50 lbs | 23 kg
Weight 77 lbs | 35 kg

- A** **Drawer**
Dimensions 6H x 12 x 17.5 in
15H x 30 x 45 cm
Capacity 10 lbs | 5 kg
- B** **Drawer**
Dimensions 11.5H x 12 x 17.5 in
29H x 30 x 45 cm
Capacity 40 lbs | 18 kg

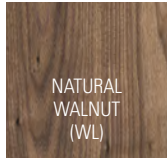
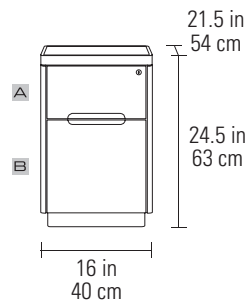

FLEXIBLE FILE STORAGE

The lower locking drawer keeps important documents organized and secure, with adjustable rails that accommodate both letter and legal-sized hanging files. A smooth soft-close mechanism ensures effortless operation, while maintaining the cabinet's clean, finished appearance.



SOLID FUNCTION

The solid wood top panel glides forward on hidden slides, providing easy access to staplers, notepads, and other desktop essentials—right where you need them.

LUMA™ STORAGE

6720 MULTIFUNCTION CABINET

- Satin-etched glass top
- Supply drawer with accessory tray
- Letter/legal file storage
- Locking drawers
- Sliding printer tray
- Rear access panel

Overall Dimensions 24.5H x 55 x 19 in | 63H x 140 x 49 cm
Weight Capacity 175 lbs | 79 kg
Weight 177 lbs | 80 kg



A Printer Compartment

Dimensions 18H x 15.5 x 16.5 in
46H x 40 x 42 cm
Capacity 25 lbs | 11 kg

B Drawer

Dimensions 5H x 31 x 11.5 in
13H x 80 x 30 cm
Capacity 30 lbs | 13 kg

C Drawer

Dimensions 9H x 31.25 x 11.5 in
24H x 80 x 31 cm
Capacity 35 lbs | 15 kg

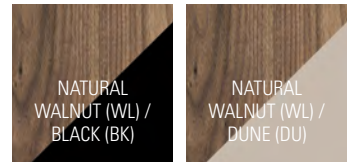
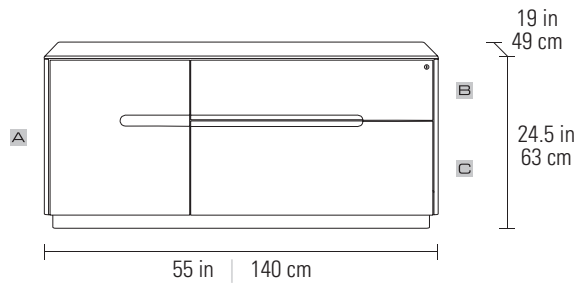

ORGANIZED INSIDE AND OUT

The top drawer includes a removable metal accessory tray with a liner to secure small items. Both drawers lock securely with a single lock.



SMART PRINTER ACCESS

The left compartment includes an adjustable glass shelf and a pull-out tray, providing full access to printers, all-in-ones, or shredders stored neatly inside the cabinet. A rear access panel allows for easy cabling.

LUMA™ STORAGE



For product info and detailed specs, visit
bdiusa.com/luma



BDI's products are packaged with recyclable materials. Dimensions, specifications, and availability are subject to change. For current specifications and availability, visit www.bdiusa.com. Listed capacities assume even distribution of weight. BDI's designs are protected by US and international patents, trade dress, and/or copyright laws. "Luma" and BDI are trademarks of Becker Designed Inc. All rights reserved. ©2025, BDI



SEQUUEL® 20 DESKS

BD

SEQUEL® 20 DESKS

DESIGN **MATTHEW WEATHERLY**

Everyone needs a workspace that is comfortable and inviting, and if it can be beautifully designed and neatly organized all the better. Designed with an emphasis on ergonomics and organization, Sequel Office is full of unique features that integrate technology into the office space while creating a comfortable and organized place to work.



6101 DESK

- Multifunction keyboard drawer with nonslip liner
- Front and back panels tilt or remove for easy access to concealed wiring
- A flip-down ledge serves as the power hub for the desk

Dimensions 29H x 66 x 24 in
74H x 168 x 61 cm
Top Capacity 200 lbs | 91 kg
Weight 135 lbs | 61 kg

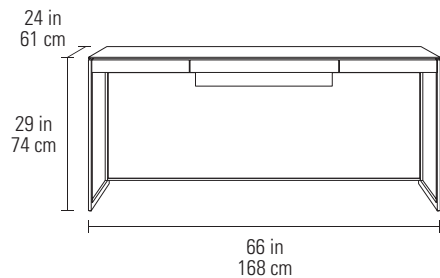

Back panel is included



6103 COMPACT DESK

- Multifunction keyboard drawer with nonslip liner
- Front panel tilts for easy access to wiring
- A flip-down ledge serves as the power hub for the desk
- Optional back panel (6108) is available separately

Dimensions 29H x 48 x 24 in
74H x 122 x 61 cm
Top Capacity 200 lbs | 91 kg
Weight 96 lbs | 44 kg

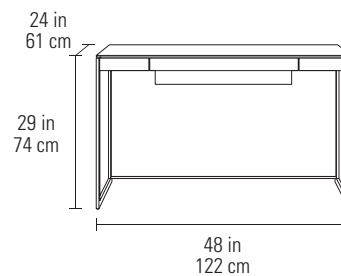

6103 does NOT include a back panel. If desired, optional **6108 Compact Desk Back Panel** is available to finish the back of the desk. Panel weight 10 lb | 4.5 kg

For product info and detailed specs, visit
bdiusa.com/sequel



6112 RETURN

- Attaches to Sequel Desk 6101 to extend the work surface
- Connect to Cabinets 6114, 6116 & 6117 to create a compact workspace

Dimensions	29H x 42 x 18 in 74H x 107 x 46 cm
Top Capacity	200 lbs 91 kg
Weight	42 lbs 19 kg

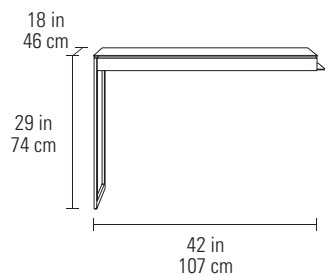

DESKS 6101 & 6103 INCLUDE A MULTIFUNCTION SYSTEM DRAWER



UNIQUE SATIN-ETCHED, BLACK TEMPERED GLASS SURFACE



EASY-ACCESS PANELS AND A POWER MANAGEMENT LEDGE (POWER STRIP NOT INCLUDED)

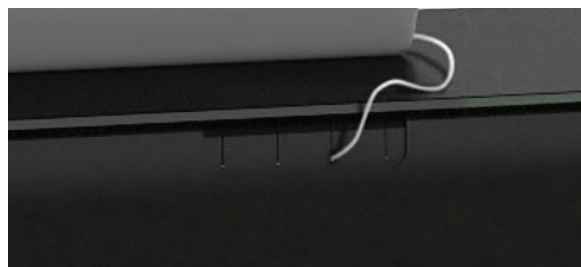

WIRE MANAGEMENT CHANNELS

For product info and detailed specs, visit bdiusa.com/sequel



STEEL
FINISH

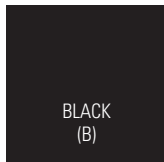

WOOD
FINISH

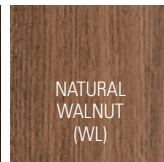
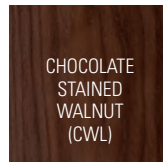

SEQUEL OPTIONS

Sequel Office is a versatile system that can be used to create office configurations of practically any size, whether creating a compact bill paying station or a luxurious executive suite. Two steel and three wood finishes provide six finish combinations.





BDI's products are packaged with recyclable materials. Dimensions, specifications, and availability are subject to change. For current specifications and availability, visit www.bdiusa.com. Listed capacities assume even distribution of weight. BDI's designs are protected by US and international patents, trade dress, and/or copyright laws. "Sequel" and BDI are trademarks of Becker Designed Inc. All rights reserved. ©2022, BDI

SEQUUEL® 20 LIFT DESKS

BDI



SEQUEL® 20 LIFT DESKS

DESIGN **MATTHEW WEATHERLY**

Setting a new standard for efficient and organized workspaces, the bar has been raised with the Sequel Lift Desks. These versatile, height-adjustable desks feature a powered leg system controlled by a digital, programmable keypad. Whether sitting, standing or somewhere in-between, the work surface is always at the perfect height. Partnering beautifully with the rest of the Sequel collection, the ergonomic Lift Desks are sure to elevate any workday.

- Satin-etched, black glass top provides a smooth work-surface
- Digital, programmable keypad can be installed on left or right of desk
- Optional keyboard storage drawer can be fitted to either desk and is lined with nonslip material
- Cable management system keeps wiring organized and out-of-sight



6151 LIFT DESK
(60" x 24" DESKTOP)

Dimensions 24.75–49.75H x 60 x 24 in
63–126H x 153 x 61 cm
Capacity 150 lbs | 68 kg
Weight 129 lbs | 59 kg

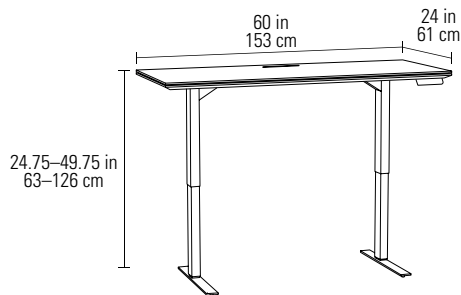

6152 LIFT DESK
(66" x 30" DESKTOP)

Dimensions 24.75–49.75H x 66 x 30 in
63–126H x 168 x 76 cm
Capacity 150 lbs | 68 kg
Weight 153 lbs | 70 kg

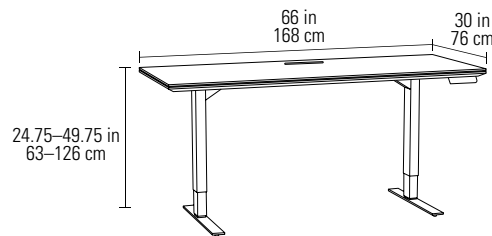

**6159 KEYBOARD /
STORAGE DRAWER**

Dimensions 2.25H x 27.75 x 11 in
5.5H x 70.5 x 27.5 cm
Weight 10 lbs | 4.5 kg

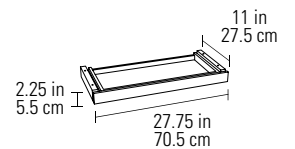

For product info and detailed specs, visit
bdiusa.com/sequel



PROGRAMMABLE DIGITAL KEYPAD



CABLE MANAGEMENT SYSTEM



PARTNERS WITH OTHER SEQUEL COMPONENTS



SUPPLIED MOUNTING KIT FOR POWER STRIP (NOT INCLUDED)



COMPATIBLE WITH THIRD-PARTY MONITOR ARMS



OPTIONAL DRAWER CAN BE ADDED TO EITHER DESK

STEEL
FINISH

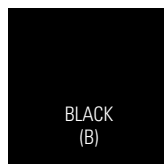

BLACK
(B)

WOOD
FINISH

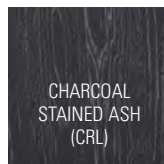

CHARCOAL
STAINED
ASH
(CRL)

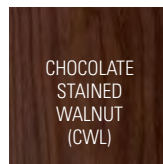

CHOCOLATE
STAINED
WALNUT
(CWL)

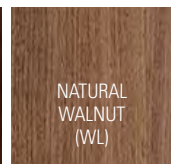

NATURAL
WALNUT
(WL)



The Lift Desk coordinates with BDI's Semblance collection



For the most up-to-date product specifications, visit www.bdiusa.com. BDI's products are protected by US patent, international patent, trade dress, and/or copyright laws. "Sequel" and BDI are trademarks of Becker Designed Inc. All rights reserved. Refer to current price list or contact BDI for specific model and finish availability. Materials and specifications subject to change without notice. BDI products are packaged with recyclable materials. ©2020, BDI

SEQUEL® 20 STORAGE

BDI



SEQUEL® 20 STORAGE

DESIGN **MATTHEW WEATHERLY**

Keeping files secured and everyday essentials close at hand, Sequel storage cabinets offer a variety of storage options for any application. File drawers accommodate letter or legal hanging file folders, and all drawers are neatly secured with the integrated lock. Stationary cabinets can be used as an anchor for a Sequel Return 6112 to create a compact workspace.



6107 LOW MOBILE FILE PEDESTAL

- Two storage drawers and a letter or legal-file drawer
- Pedestal rests on locking casters
- Comes with both satin-nickel and black hardware

Dimensions 24.5H x 15.25 x 21 in
62H x 39 x 53 cm
Caster Height 3 in | 7.5 cm
Weight 64 lbs | 29 kg

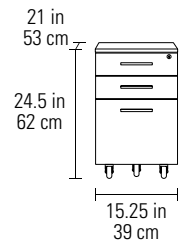

6114 3-DRAWER FILE CABINET

- Two storage drawers and a letter or legal-file drawer
- Cabinet can be attached to Return 6112

Dimensions 29H x 15.25 x 18 in
74H x 39 x 46 cm
Base Height 2.75 in | 7 cm
Weight 84 lbs | 38 kg

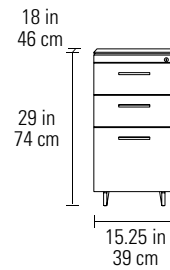



6116 LATERAL FILE CABINET

- Two drawers for legal and/or letter-sized hanging files
- Anti-tip hardware allows only one drawer to open at a time
- Cabinet can be attached to Return 6112

Dimensions 29H x 35 x 18 in
74H x 89 x 46 cm
Base Height 2.75 in | 7 cm
Weight 144 lbs | 65 kg

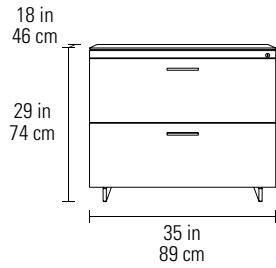

6117 MULTIFUNCTION CABINET

- Compartment includes a pullout printer tray and an adjustable shelf
- Two storage drawers for supplies and a file drawer for hanging files
- Cabinet can be attached to Return 6112

Dimensions 29H x 35 x 18 in
74H x 89 x 46 cm
Printer Compartment 10.7H x 21.7 x 17.2 in | 27.3H x 55.2 x 43.9 cm
Base Height 2.75 in | 7 cm
Weight 164 lbs | 75 kg

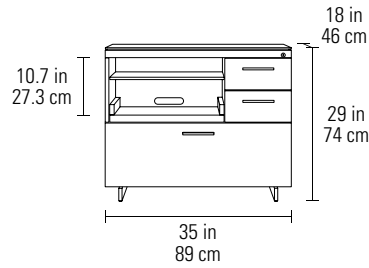

For product info and detailed specs, visit
bdiusa.com/sequel

STEEL
FINISH

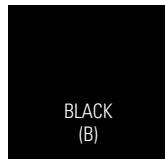

WOOD
FINISH

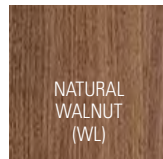
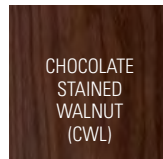



For the most up-to-date product specifications, visit www.bdiusa.com. BDI's products are protected by US patent, international patent, trade dress, and/or copyright laws. "Sequel" and BDI are trademarks of Becker Designed Inc. All rights reserved. Refer to current price list or contact BDI for specific model and finish availability. Materials and specifications subject to change without notice. BDI products are packaged with recyclable materials. ©2020, BDI



SEQUEL® STUDIO

BDI

SEQUEL® STUDIO DESKS

DESIGN **MATTHEW WEATHERLY**

Sequel Studio is a streamlined system of four essential pieces designed to create refined, real-world workspaces. Thoughtfully integrated power, clean cable management, and precisely matched engineered surfaces work together to deliver a workspace that feels intentional, modern, and effortlessly coordinated.

6601 DESK

Designed for everyday performance with integrated power and refined cable management, the Sequel Studio Desk anchors the collection with a clean, architectural silhouette.

- Integrated power strip included—serving as the desk's central power hub
- Front and rear access panels for easy reach from either side
- Interior wiring panel with included Velcro® straps for clean, concealed cable routing
- Built-in work drawer keeps essentials within reach and the desktop clear

Overall Dimensions 29H x 66 x 24 in | 74H x 168 x 60 cm

Top Maximum Capacity 100 lbs | 45 kg

Weight 115 lbs | 52 kg

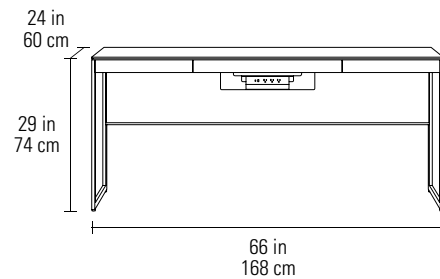

POWER STRIP AND CABLE MANAGEMENT

The integrated power strip serves as the central power hub of the desk. An interior wiring panel with included Velcro straps keeps cables organized and concealed.



KEYBOARD/STORAGE DRAWER

A versatile drawer doubles as a keyboard and mouse tray, lined with non-slip neoprene for a soft, secure surface.



ACCESS PANELS

Front and rear removable panels provide easy access to wiring, power, or concealed peripherals.

SEQUEL® STUDIO DESKS

6612 RETURN

The Return extends the workspace with seamless alignment and flexible mounting options—creating a cohesive workstation that adapts to its environment.

- Mounts to the left or right side of the Desk and Multifunction Cabinet
- Expands surface area while maintaining a clean footprint
- Matches seamlessly in height and material for a unified look
- Supports flexible workstation layouts—from single desks to shared setups

Overall Dimensions 29H x 42 x 18 in | 74H x 107 x 46 cm

Top Maximum Capacity 100 lbs | 45 kg

Weight 64 lbs | 29 kg

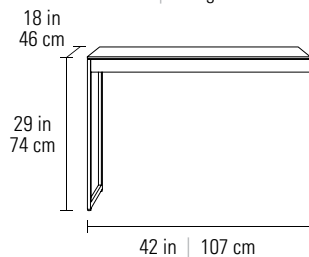

Return mounted to Sequel Studio Desk



Return mounted to Sequel Studio Multifunction Cabinet

SEQUEL® STUDIO STORAGE

6607 MOBILE FILE PEDESTAL

Compact, secure, and designed to move with you, the Sequel Studio Mobile File Pedestal adds organized storage wherever it's needed—tucking neatly beneath the Desk or standing independently within the workspace.

- Letter and/or legal hanging file compatible
- Single-lock security system
- Locking casters for flexible placement
- Fits neatly beneath Desk

Overall Dimensions 24.5H x 15.5 x 21.5 in | 62H x 39 x 55 cm
Weight Capacity 100 lbs | 45 kg
Weight 64 lbs | 29 kg

A Drawer

Dimensions 3.5H x 12 x 15 in
9H x 30 x 38 cm
Capacity 10 lbs | 4 kg

B Drawer

Dimensions 10H x 12 x 15 in
25H x 30 x 39 cm
Capacity 40 lbs | 18 kg

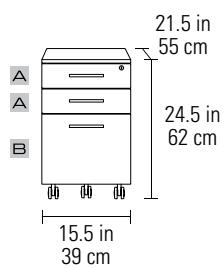

SECURE STORAGE

Locking storage for everyday essentials



SOLID FUNCTION

Accommodates letter and/or legal files

SEQUEL® STUDIO STORAGE

6617 MULTIFUNCTION CABINET

The Sequel Studio Multifunction Cabinet combines storage, printer support, and expanded worksurface potential in one refined component. Designed to integrate with the Desk and/or Return, it anchors flexible workstation layouts while maintaining Studio's clean architectural profile.

- Pullout printer tray
- Letter/legal file drawer
- Single-key locking system
- Integrated plinth base

Overall Dimensions 29H x 35 x 18 in | 74H x 89 x 47 cm
Weight Capacity 100 lbs | 45 kg
Weight 168 lbs | 76 kg



A Printer Compartment

Dimensions 10.5H x 21.5 x 15.5 in
27H x 55 x 40 cm
Capacity 25 lbs | 11 kg

B Drawer

Dimensions 5H x 9 x 5 in
13H x 23 x 13 cm
Capacity 10 lbs | 5 kg

C Drawer

Dimensions 10H x 31.5 x 15 in
26H x 80 x 26 cm
Capacity 50 lbs | 23 kg

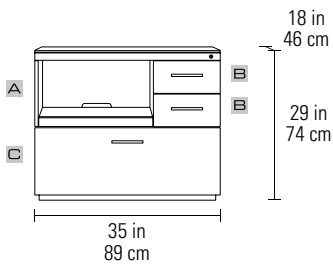

FLEXIBLE LAYOUT

Designed to mount to the Return to create flexible workstation layout.



SMART PRINTER ACCESS AND FILE STORAGE

Dedicated printer storage compartment and accommodates letter and/or legal hanging files.

SEQUEL® STUDIO



For product info and detailed specs, visit bdiusa.com/sequel-studio

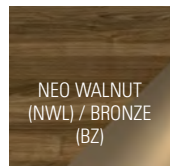
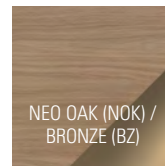

BDI's products are packaged with recyclable materials. Dimensions, specifications, and availability are subject to change. For current specifications and availability, visit www.bdiusa.com. Listed capacities assume even distribution of weight. BDI's designs are protected by US and international patents, trade dress, and/or copyright laws. "Sequel", "Sequel Studio" and BDI are trademarks of Becker Designed Inc. All rights reserved. ©2026, BDI

SIGMA™ OFFICE

BDI



SIGMA Whether outfitting a complete office or creating a compact workstation at home, Sigma is a fresh approach to serious office furniture. Combine work surface and storage options to create a custom workspace in any space.

SIGMA™ OFFICE

DESIGN **BDI DESIGN STUDIO**

6901 DESK

- Integrated system drawer front flips down for use with a keyboard and mouse
- Easy-access front and back panels tilt or remove for access to concealed wiring
- A wire management ledge provides space for a power strip and connections

Dimensions 29H x 66 x 24 in | 74H x 168 x 61 cm
Top Capacity 75 lbs | 34 kg
Weight 131 lbs | 59 kg

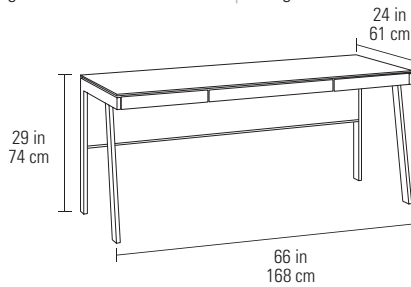

6902 RETURN

- Connects to Sigma Desk 6901 to extend the workspace
- Creates a convenient space for cross-desk collaboration

Dimensions 29H x 42 x 18 in | 74H x 107 x 46 cm
Top Capacity 50 lbs | 23 kg
Weight 41 lbs | 19 kg

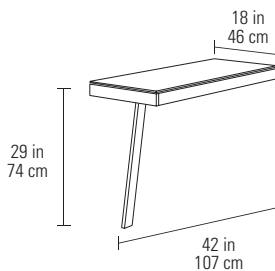

6903 COMPACT DESK

- Integrated system drawer front flips down for use with a keyboard and mouse
- Easy-access front and back panels tilt or remove for access to concealed wiring
- A wire management ledge provides space for a power strip and connections

Dimensions 29H x 48 x 24 in | 74H x 122 x 61 cm
Top Capacity 65 lbs | 30 kg
Weight 101 lbs | 46 kg

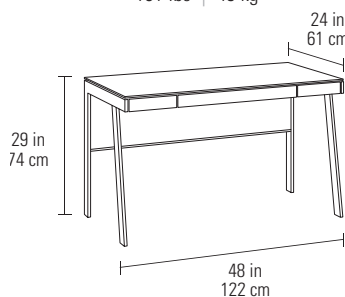

6907 MOBILE FILE PEDESTAL

- Three drawers are secured with one lock
- Two storage drawers and one letter/legal file drawer
- Pedestal rests on locking casters
- Designed to fit neatly under the Sigma Desk 6901

Dimensions 25.5H x 15.75 x 21 in | 64H x 40 x 53 cm
Weight 64 lbs | 29 kg

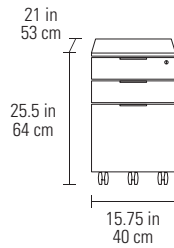

6917 MULTIFUNCTION CABINET

- Cabinet includes two storage drawers and a file drawer for letter/legal hanging files
- Open compartment features a pullout printer tray and adjustable paper shelf
- Integrated lock keeps contents secure
- Perfect all-purpose piece for a small office

Dimensions 29H x 35 x 18 in | 74H x 89 x 46 cm
Printer Compartment 10.25H x 21.5 x 17.25 in | 26.4H x 55.4 x 43.7 cm
Printer Tray Capacity 20 lbs | 9 kg
File Drawer Capacity 75 lbs | 34 kg
Weight 133 lbs | 60 kg

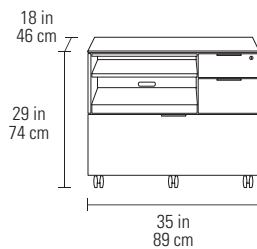

For product info and detailed specs, visit
bdiusa.com/sigma

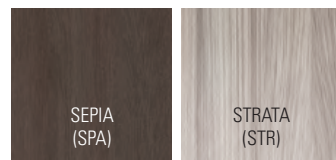



Desks 6901 & 6903 include a multifunction system drawer that is lined with non-slip material to keep a keyboard, mouse and rechargeable items in place.



A wire management ledge provides a home for a power strip (not included). Desk panels tilt or remove for easy access to concealed wiring.



Satin-etched glass work surfaces are smooth to the touch and resistant to fingerprints and scratches.



The included back panels allow Desks 6901 & 6903 to float in a room, or panels can be removed for direct access to wall outlets.



For the most up-to-date product specifications, visit www.bdiusa.com. BDI's products are protected by US patent, international patent, trade dress, and/or copyright laws. "Sigma" and BDI are trademarks of Becker Designed Inc. All rights reserved. Refer to current price list or contact BDI for specific model and finish availability. Materials and specifications subject to change without notice. BDI products are packaged with recyclable materials. ©2019, BDI



VOCOA®

BD

VOCA®

DESIGNED IN DENMARK

Designed with comfort and flexibility at its core, the ergonomically engineered Voca chair provides the ideal home base for daily operations. The chair's breathable mesh adapts to the body's natural contours, providing just the right amount of support. Constructed with premium materials and rigorously-tested hardware, Voca is BIFMA certified, suitable for any application.

3501 OFFICE CHAIR

Dimensions 45–51.5H x 28 x 28 in | 114–131H x 71 x 71 cm

Back Height 45–51.5 in | 114–131 cm

Seat Height 18.5–22 in | 47–56 cm

Seat Width 19 in | 48 cm

Seat Depth 17–19 in | 43–48 cm

Armrest Height 26–29.5 in | 66–75 cm

Max User Weight 300 lbs | 136 kg

Weight 50 lbs | 22.5 kg

5-year Limited Warranty

For product info and detailed specs, visit
bdiusa.com/voca



COMFORT HEADREST

Cushioned headrest provides neck support, adjusting in height in unison with the back.

PERFORMANCE MESH

Durable mesh seat and back evenly distribute weight while allowing airflow, keeping you cool and comfortable.

ADJUSTABLE BACKREST

Adjusting to your height and build, the complete back assembly easily adjusts up or down with a push or pull.

LUMBAR SUPPORT

A cushioned lumbar panel provides lower back support for extended periods of sitting.

ADJUSTABLE ARMRESTS

Armrests adjust in every direction—up/down, in/out, front/back—to provide tailored alignment and ergonomic support for your arms and wrists.

ADJUSTABLE SEAT HEIGHT

A gentle pull on a lever adjusts the seat on its pneumatic support to achieve the perfect height.

TILT TENSION CONTROL

Fine-tune the feel of your chair by adjusting the amount of force needed to recline.

ADJUSTABLE SEAT DEPTH

The seat glides front or back to ensure a custom fit no matter your size. The seat's smoothly curved edges provide added leg comfort.

SYNCHRO-TILT

Seat and back panel tilt in perfect harmony, keeping legs straight while reclining. The tilt feature locks into one of four recline positions.

POLISHED ALUMINUM BASE

The durable aluminum base provides sturdy support and is resistant to scuffs and scratches. Pure-glide casters provide smooth motion on both carpeted or hard surfaces.



SLATE /
ALUMINUM
(SLA)



For the most up-to-date product specifications, visit www.bdiusa.com. BDI's products are protected by US patent, international patent, trade dress, and/or copyright laws. "Voca" and BDI are trademarks of Becker Designed Inc. All rights reserved. Refer to current price list or contact BDI for specific model and finish availability. Materials and specifications subject to change without notice. BDI products are packaged with recyclable materials. ©2021, BDI

Arrange. Support. **Interact.**



BDIUSA.COM

BDI's table collections will be the center of attention in any room. With classic lines, integrated storage, and unique function, they are more than just a place to kick up your heels at the end of the day.

Our range of coffee and console tables come in all shapes and sizes—as well as heights and levels—making them great for work or play. Our laptop tables provide a convenient work surface always close at hand, and just as easily serve as a snack station while relaxing in front of the TV.

TABLES

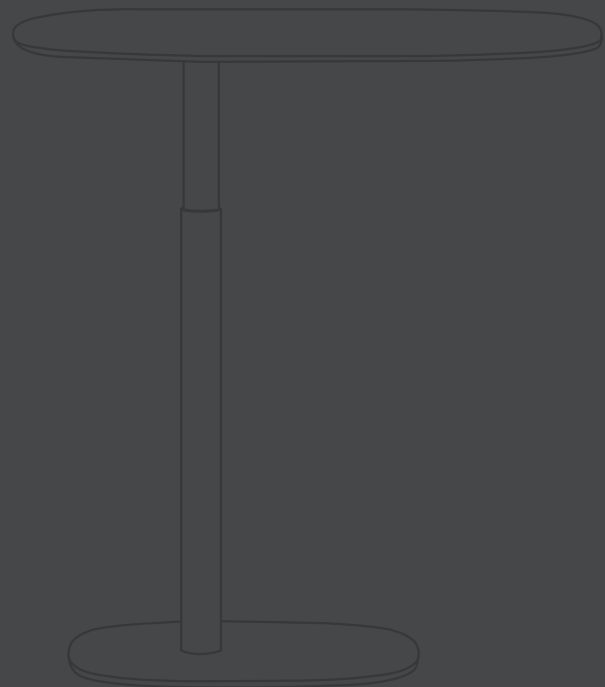



BINK®

BD

BINK®

DESIGN **MATTHEW WEATHERLY**

The perfect companion anywhere you work, live or play. Whether on the computer at the sofa, lounging poolside or simply snacking in front of the TV, this convenient mobile laptop table goes anywhere you want. With a soft, contoured shape, Bink creates a comfortable workspace for a laptop or tablet or is an attractive resting spot for your favorite libation.

1025 LAPTOP TABLE

Overall Dimensions 24H x 19.25 x 14.75 in | 61H x 49 x 37 cm
Top Shelf Capacity 25 lbs | 11 kg
Weight 25 lbs | 11 kg

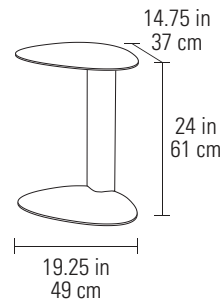

For product info and detailed specs, visit bdiusa.com/bink

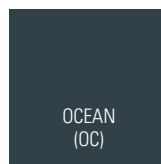
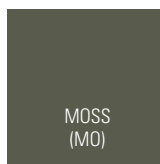
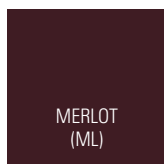
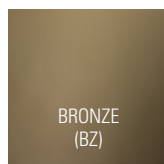

BDI's products are packaged with recyclable materials. Dimensions, specifications, and availability are subject to change. For current specifications and availability, visit www.bdiusa.com. Listed capacities assume even distribution of weight. BDI's designs are protected by US and international patents, trade dress, and/or copyright laws. "Bink" and BDI are trademarks of Becker Designed Inc. All rights reserved. ©2026, BDI



CLOUD 9TM

BDI

CLOUD 9™

DESIGN **MATTHEW WEATHERLY**

The Cloud 9 collection features durable porcelain surfaces, soft to the touch, yet resistant to scratches, heat and staining. The versatile coffee table's top raises to the perfect height for working on a laptop or enjoying a meal on the sofa, while remotes and other essentials remain accessible when the top is closed. The collection's end table and console are perfect complements, but also striking standalone pieces on their own.

1182 LIFT COFFEE TABLE

Dimensions	16–24H x 52 x 31 in 41–61H x 132 x 79 cm
Maximum Capacity	
Open	30 lbs 13.5 kg
Closed	100 lbs 45 kg
Weight	85 lbs 38.5 kg



HOLD ON

Contoured finger grip under the top provides security when in motion

PORCELAIN TOP

Durable and resistant to scratches, the coffee table's top lifts to a height of 24"

SMOOTH OPERATOR

The pneumatic lift provides controlled movement and a wide range of motion, extending the table forward by 12.5 in | 31.5 cm

EASY ACCESS

Store a laptop or magazines within easy reach in the lined storage compartment, accessible from the sofa-side when the table is closed

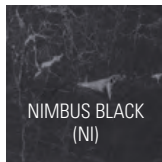
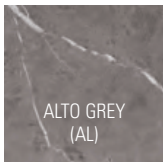
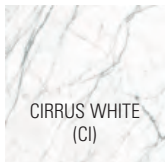



1186 END TABLE

Dimensions 24H x 30 x 15 in | 61H x 76.5 x 38.5 cm
Top Panel Capacity 50 lbs | 23 kg
Weight 39 lbs | 18 kg



1183 CONSOLE

Dimensions 31H x 50 x 16 in | 78.5H x 127 x 40.5 cm
Top Panel Capacity 50 lbs | 23 kg
Weight 71 lbs | 32 kg

For product info and detailed specs, visit
bdiusa.com/cloud9

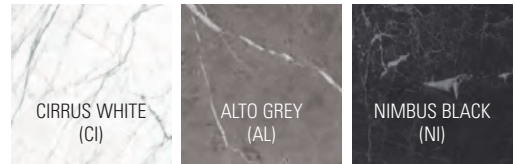



BDI's products are packaged with recyclable materials. Dimensions, specifications, and availability are subject to change. For current specifications and availability, visit www.bdiusa.com. Listed capacities assume even distribution of weight. BDI's designs are protected by US and international patents, trade dress, and/or copyright laws. "Cloud 9" and BDI are trademarks of Becker Designed Inc. All rights reserved. ©2022, BDI

CORRA™ TABLES

BDI



CORA™

DESIGN **MATTHEW WEATHERLY**

Perfectly coordinating with BDI's most popular entertainment and storage collections, Cora tables provide concealed storage at your fingertips. Featuring a striking louvered design, low-profile lined drawers are easily accessible. Available in Natural Walnut and Ebonized Ash finishes.

1172 COFFEE TABLE

Dimensions	16H x 50 x 26 in 41H x 127 x 66 cm
Capacity	50 lbs 23 kg
Drawer Capacity	20 lbs 9 kg
Weight	137 lbs 62 kg

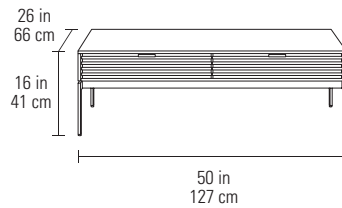

1173 CONSOLE TABLE

Recommended TV Size	up to 65"
Dimensions	30H x 60 x 16 in 77H x 153 x 41 cm
Capacity	100 lbs 45 kg
Drawer Capacity	20 lbs 9 kg
Weight	128 lbs 58 kg

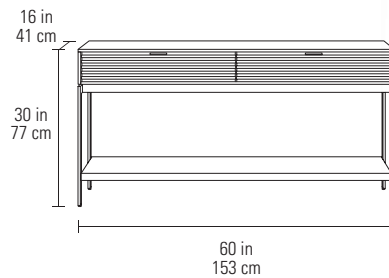

1176 END TABLE

Dimensions	24H x 22 x 22 in 61H x 56 x 56 cm
Capacity	100 lbs 45 kg
Drawer Capacity	20 lbs 9 kg
Weight	70 lbs 32 kg

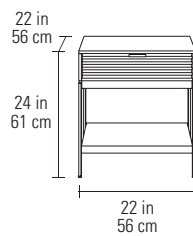

For product info and detailed specs, visit
bdiusa.com/cora



LOW PROFILE

Slim drawer pulls provide access to two full-depth drawers on the coffee table and console, one on the end table.

LINED DRAWERS

Drawers are lined with soft material to protect drawer contents and keep them in place. Removable for cleaning.

FULLY FINISHED

The coffee table includes solid wood slats on the front and back for a matching aesthetic.

Cora Coffee Table 1172 in Ebonized Ash



A full 60" wide, the Cora Console is multi-use, at home in an entry, behind a sofa, or under a TV. A wire management hole allows inclusion of small electronics.

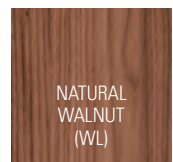
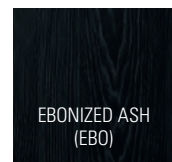



Cora Console 1173 in Natural Walnut



Cora End Table 1176 and Coffee Table 1172 in Ebonized Ash



DINNO™ TABLES

BD



DINO™

DESIGN **LOUIS A. LARA**

The popular Dino table has been refreshed for a new generation. With its soft triangular design, Dino is a welcoming and comfortable shape for use with oddly-shaped seating areas or sectionals. The collection's grey-tinted glass top surface is affixed to brushed metal legs, secured to the floating lower shelf. Available in five finishes.

1363 LARGE COFFEE TABLE

Dimensions 15.5H x 55 x 33.5 in
40H x 140 x 85 cm
Shelf Clearance 8.75 in | 22.5 cm
Weight 85 lbs | 39 kg

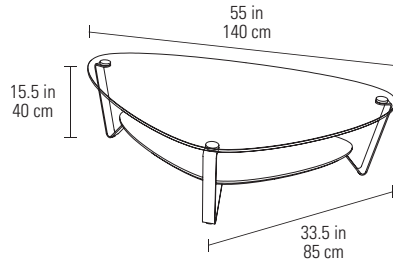

1364 SMALL COFFEE TABLE

Dimensions 15.5H x 44 x 27 in
40H x 112 x 68 cm
Shelf Clearance 8.75 in | 22.5 cm
Weight 55 lbs | 25 kg

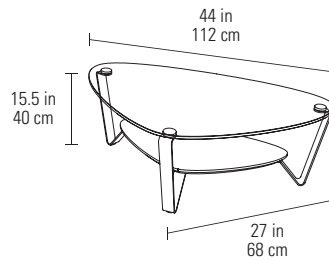

1367 END TABLE

Dimensions 21H x 29 x 21.5 in
53.5H x 74 x 54 cm
Shelf Clearance 11.25 in | 29 cm
Weight 37 lbs | 17 kg

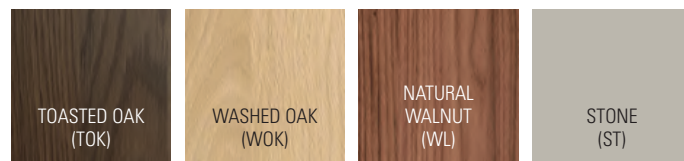
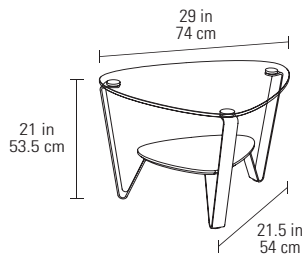



Dino Large Coffee Table 1363 with End Table 1367 in Natural Walnut



Dino Large Coffee Table 1364 with End Table 1367 in Toasted Oak



Dino End Table 1367 and Large Coffee Table 1363 in Toasted Oak



Dino End Table 1367 in Natural Walnut





Available in two sizes and configurations, the Linq nightstands are equally at home nestled next to the bed or serving as the recharging hub of the living room.



LINQ™ NIGHTSTANDS

DESIGN **MATTHEW WEATHERLY**

Engineered as the ideal nightstand, these multi-functional pieces also make a welcome sofa-side addition. One-part table and two-parts command center, they include integrated power stations, a sliding top panel that gently glides things forward for easier reach, and generous storage. You can learn more about the Linq tables in the Bedroom section of this catalog.

9181 22" NIGHTSTAND

Dimensions 25H x 22 x 20 in | 64H x 56 x 51 cm
 Weight 79 lbs | 36 kg



9182 28" NIGHTSTAND

Dimensions 25H x 28 x 20 in | 64H x 71 x 51 cm
 Weight 101 lbs | 46 kg



Both Linq nightstands feature a sliding top.



Power strip and wire wraps in the back.



Model 9182 includes a pull-out middle shelf.



BDI's products are packaged with recyclable materials. Dimensions, specifications, and availability are subject to change. For current specifications and availability, visit www.bdiusa.com. Listed capacities assume even distribution of weight. BDI's designs are protected by US and international patents, trade dress, and/or copyright laws. "Linq" and BDI are trademarks of Becker Designed Inc. All rights reserved. ©2023, BDI



REVEAL™

BD

REVEAL™

DESIGN **MATTHEW WEATHERLY**

Ready to give any occasion a lift, the Reveal coffee table's top glides to a comfortable height for seated use. Whether used for working from the sofa or enjoying snacks in front of the TV, the satin-etched glass top provides a comfortable surface. Lower compartments keep stored items within convenient reach. The partnering side table features three levels of storage.

1192 LIFT COFFEE TABLE

- Satin-etched glass top is smooth to the touch and forgiving of fingerprints and daily use
- Pneumatic lift mechanism provides smooth motion
- Wide range of motion extends table forward by 12.5 in | 31.5 cm
- Side storage compartments provide easy access for everyday items

Dimensions	15.75–23.75H x 48 x 27 in 40–60H x 122 x 69 cm
Maximum Capacity	
Open	30 lbs 13.5 kg
Closed	100 lbs 45 kg
Weight	85 lbs 38.5 kg



For product info and detailed specs, visit bdiusa.com/reveal

SOFT TOUCH

Satin-etched glass top surface is smooth to the touch yet resistant to scuffs and fingerprints

GET A GRIP

Contoured finger grip provides security when in motion

SMOOTH OPERATOR

The pneumatic lift provides controlled movement and a wide range of motion, extending the table forward by 12.5 in | 31.5 cm

STORE MORE

Generous interior storage and easy-access side compartments provide multiple storage solutions for everyday essentials



1196 END TABLE

- The table's size is designed to align with the depth of a sofa
- Open on both sides, great for floating in a room
- Satin-etched glass top and shelf
- Divided center compartment can conceal a power strip
- A wire-management opening connects divided compartment for cable routing

Dimensions	23.75H x 14 x 30 in 60.5H x 35.5 x 76.5
Top Panel Capacity	50 lbs 23 kg
Shelf Clearance	12 in 30.5 cm
Bottom Shelf Capacity	50 lbs 23 kg
Weight	39.5 lbs 18 kg

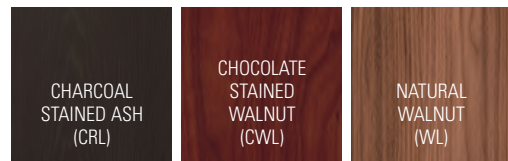



BDI's products are packaged with recyclable materials. Dimensions, specifications, and availability are subject to change. For current specifications and availability, visit www.bdiusa.com. Listed capacities assume even distribution of weight. BDI's designs are protected by US and international patents, trade dress, and/or copyright laws. "Reveal" and BDI are trademarks of Becker Design Inc. All rights reserved. ©2022, BDI



SERIF™

BDI

SERIF™

DESIGN **JEFF BARE**

A uniquely adjustable table that takes your work surface to new heights. Gliding smoothly on its pneumatic cylinder with a simple push or pull, Serif is equally at home hovering over the arm of a sofa as it is nestled neatly in your lap.

- Rounded edge creates a comfortable work surface
- Pneumatic cylinder provides smooth motion
- Low profile weighted base slides under seating to keep table close and stable
- Nylon glides provide easy movement without marring hard surfaces
- Aluminum and steel construction provides sturdy support

1045 METAL TOP LIFT LAPTOP TABLE

Dimensions 20.5–30.5H x 22 x 13 in | 52–78H x 55 x 33 cm
Maximum Capacity 25 lbs | 11 kg
Weight 20.5 lbs | 9.5 kg

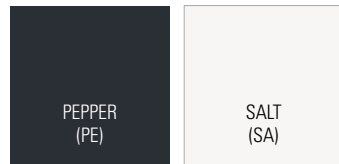

SERIF™

1046 SOLID WOOD TOP LIFT LAPTOP TABLE

Dimensions 21.5–31.5H x 22 x 13 in | 55–80H x 55 x 33 cm
Maximum Capacity 25 lbs | 11 kg
Weight 20.5 lbs | 9.5 kg

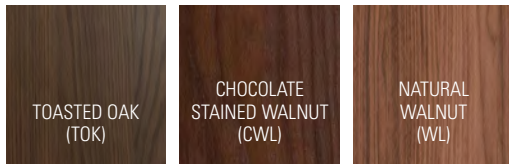

For product info and detailed specs, visit
bdiusa.com/serif



BDI's products are packaged with recyclable materials. Dimensions, specifications, and availability are subject to change. For current specifications and availability, visit www.bdiusa.com. Listed capacities assume even distribution of weight. BDI's designs are protected by US and international patents, trade dress, and/or copyright laws. "Serif" and BDI are trademarks of Becker Designed Inc. All rights reserved. ©2025, BDI

TERRACE™

BDI

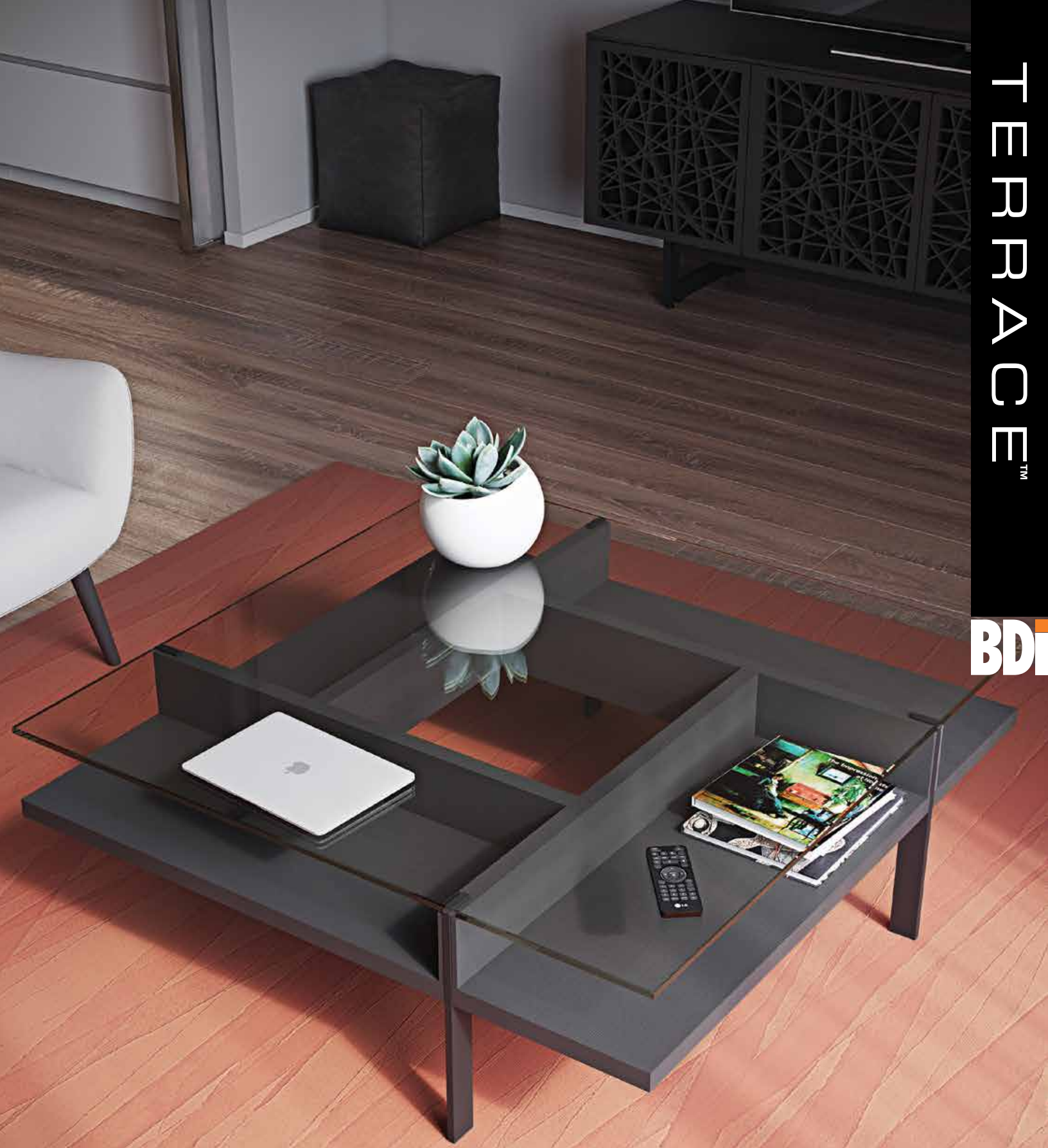

TERRACE With a pinwheel design and unique details, TERRACE is a beautifully functional table grouping. Combining tempered glass tops, thick wood panels and rigid steel support, the collection comes in two coffee table sizes, as well as an end table and console. Available in Natural Walnut and Charcoal Stained Ash finishes, TERRACE partners perfectly with many of BDI's most popular media furniture designs.

TERRACE™

DESIGN **MATTHEW WEATHERLY**

- Generously-sized, the square coffee table pairs perfectly with sectional sofas.
- Open yet segregated areas provide open storage, with an enclosed feel.
- Tempered glass tops provide strength and security.

1150 SQUARE COFFEE TABLE

Dimensions 16.25H x 44 x 44 in | 41H x 112 x 112 cm
Shelf Clearance 4.25 in | 11 cm
Weight 145 lbs | 66 kg



1152 RECTANGULAR COFFEE TABLE

Dimensions 16.25H x 44 x 34 in | 41H x 112 x 87 cm
Shelf Clearance 4.25 in | 11 cm
Weight 124 lbs | 56 kg



1153 CONSOLE

Dimensions 30H x 50 x 13.25 in | 77H x 127 x 34 cm
Shelf Height Clearance 4.75 in | 12 cm
Weight 84 lbs | 38 kg



1156 END TABLE

Dimensions 22.25H x 22.25 x 22.25 in | 56H x 57 x 57 cm
Shelf Height Clearance 5 in | 12 cm
Weight 45 lbs | 20 kg



1152 and 1156 in Charcoal Stained Ash finish

For product info and detailed specs, visit
bdiusa.com/terrace

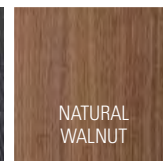

Display. Curate. **Elevate.**



BDIUSA.COM

SHELVING

BDI's shelving systems take things to the next level. Distinguished by their clean lines, classic details and rock-solid engineering, our shelves are the perfect addition to practically any home or office space. Perfect for displaying personal photos, beloved artwork, or treasured knickknacks, go vertical with shelving to get maximum use out of a minimal footprint.

With modern styling that complements many decors, BDI shelves can be used in multiple configurations to create an impressive library wall, floating off a wall as a functional room divider, or simply serving as the focal point of a cozy reading nook.

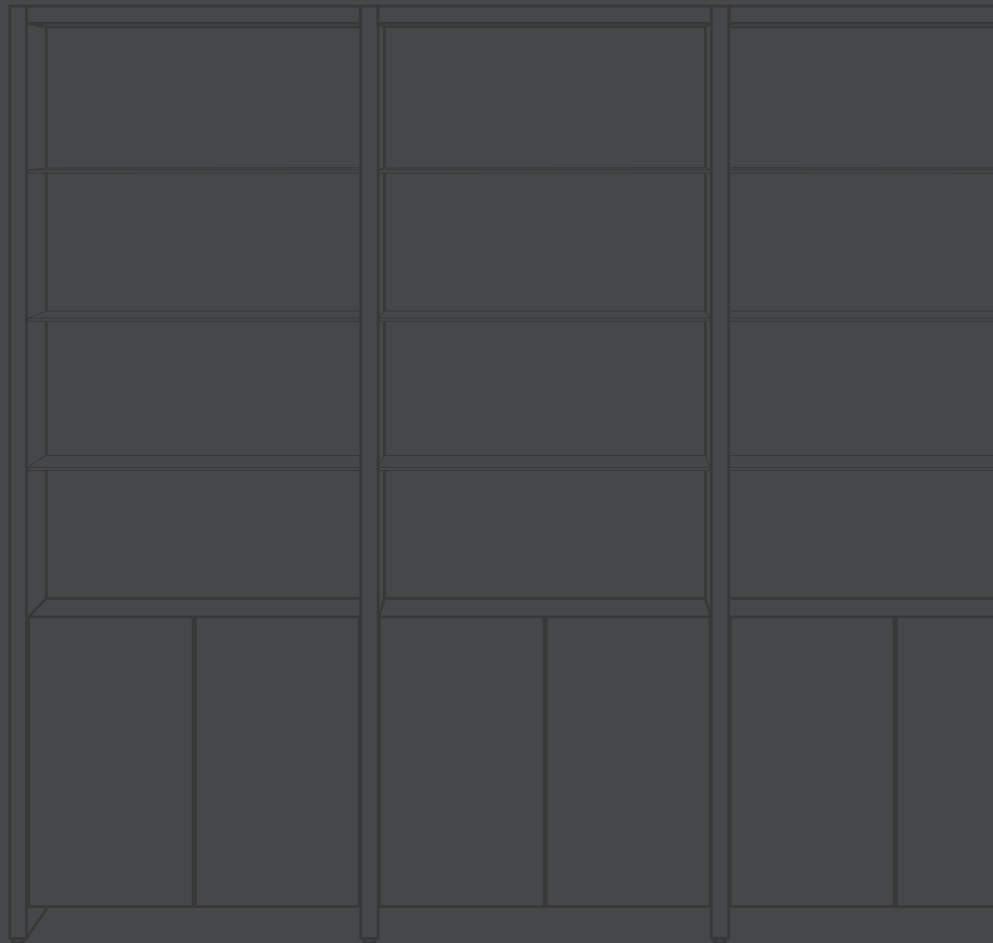

EILEEN™

BD



EILEEN™

DESIGN **MATTHEW WEATHERLY**

The Eileen shelf looks great solo or combined in groups, filling an entire wall. Eileen is incredibly solid and its tempered, grey-tinted glass shelves are perfect for holding books or displaying your favorite collectibles.

5166 LEANING SHELF

Dimensions	74H x 34.25 x 15.5 in 188H x 87 x 40 cm
Shelf Depth (Top to Bottom)	7.5–13.75 in 19–35 cm
Shelf Clearance (See Drawing)	12.25–13.75 in 31–35 cm
Shelf Capacity	50 lbs 23 kg
Weight	86 lbs 39 kg

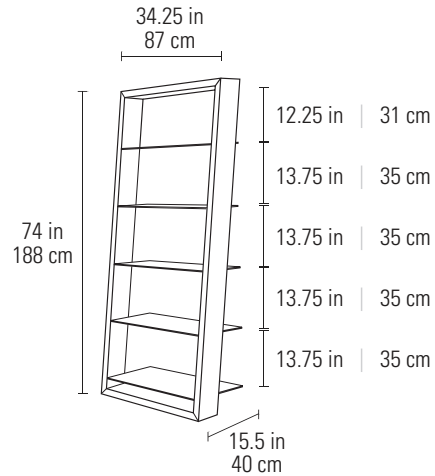

For product info and detailed specs, visit
[bdiusa.com/eileen](https://www.bdiusa.com/eileen)

CHARCOAL
STAINED
ASH
(CRL)

CHOCOLATE
STAINED
WALNUT
(CWL)

NATURAL
WALNUT
(WL)

SATIN WHITE
(SW)



BDi's products are packaged with recyclable materials. Dimensions, specifications, and availability are subject to change. For current specifications and availability, visit www.bdiusa.com. Listed capacities assume even distribution of weight. BDI's designs are protected by US and international patents, trade dress, and/or copyright laws. "Eileen" and BDI are trademarks of Becker Designed Inc. All rights reserved. ©2024, BDI

LINEA™ SHELVES



BD

LINEA™ SHELVES

DESIGN **MATTHEW WEATHERLY**

Whether fitting perfectly into the smallest nook or spanning a library to create a complete wall system, Linea Shelves offer a versatile storage solution. Featuring floating glass display shelves above and enclosed storage below, shelves are available in single or double widths. Select an individual shelf, a preconfigured system, or customize your perfect Linea solution by adding on extension shelves as needed.

DIMENSIONS: Height: 83.75 in | 213 cm ■ Depth: 14 in | 36 cm



5801 SINGLE SHELF

Width 18.25 in | 46 cm
Weight 122 lbs | 55.5 kg



5802 DOUBLE SHELF

Width 33 in | 83.5 cm
Weight 175 lbs | 80 kg



SYSTEM **580012**

Width 49.75 in | 126 cm
Weight 291 lbs | 132 kg



SYSTEM **580022**

Width 64.5 in | 163.5 cm
Weight 346 lbs | 157 kg



SYSTEM **580121**

Width 66.25 in | 168 cm
Weight 401 lbs | 182 kg



System 580012 in Charcoal Stained Ash



SYSTEM **580212**

Width 81 in | 205.5 cm
 Weight 429 lbs | 195 kg



SYSTEM **580222**

Width 96 in | 243.5 cm
 Weight 511 lbs | 232 kg



Linea Shelves provide a perfect combination of open display space and enclosed storage



Soft-close doors conceal an adjustable glass shelf



A wire routing channel in the lower cabinet allows placement of concealed small electronics



Linea makes a striking room divider, secured to a wall at one end with the supplied mounting hardware

CUSTOMIZE YOUR LINEA SYSTEM

Create a Linea System of practically any size by adding on a single or double shelf. Extension kits 5801A and 5802A include a divider panel that will insert into any configuration to extend a Linea Shelf to fill any space.

DIVIDER



5801A SINGLE SHELF EXTENSION

DIVIDER



5802A DOUBLE SHELF EXTENSION

END END DIVIDER DIVIDER



5802

5801A

5802A

END DIVIDER END



SPECIFICATIONS

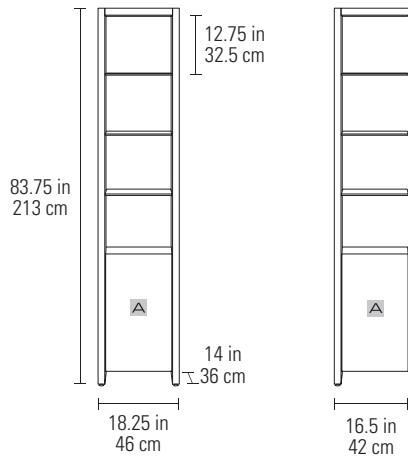

5801 SINGLE SHELF

Width 18.25 in | 46 cm
Weight 122 lbs | 55.5 kg

Dimensions

Height 83.75 in | 213 cm
Depth 14 in | 36 cm

Shelf Width

Single 14.75 in | 37.5 cm
Double 29.5 in | 75 cm

Shelf Depth 13.75 in | 35 cm

Shelf Clearance 12.75 in | 32.5 cm

Shelf Capacity 100 lbs | 45 kg

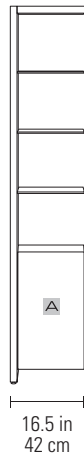

5801A SINGLE SHELF EXTENSION

Width 16.5 in | 42 cm
Weight 94 lbs | 42.5 kg

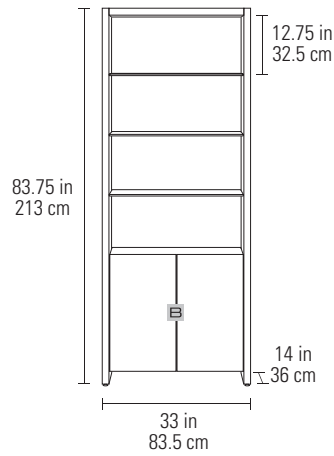

5802 DOUBLE SHELF

Width 33 in | 83.5 cm
Weight 175 lbs | 80 kg

A Single Compartment

Dimensions 24H x 13.5 x 12.25 in
61H x 34 x 31 cm

B Double Compartment

Dimensions 24H x 28.25 x 12.25 in
61H x 71.5 x 31 cm

Adjustable Shelf Increments 2.5 in | 64 mm; 3 positions

Adjustable Shelf Capacity 50 lbs | 23 kg

Bottom Shelf Capacity 50 lbs | 23 kg

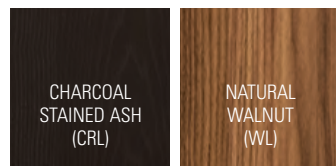



BDI's products are packaged with recyclable materials. Dimensions, specifications, and availability are subject to change. For current specifications and availability, visit www.bdiusa.com. Listed capacities assume even distribution of weight. BDI's designs are protected by US and international patents, trade dress, and/or copyright laws. "Linea" and BDI are trademarks of Becker Designed Inc. All rights reserved. ©2025, BDI

Learn. Compare. **Discover.**



BDIUSA.COM

Meet the **Designers.**

Driven by design. It's not just something that we say, it's something that we live and breathe at all levels of our company. Meet the talented team of award-winning designers behind BDI's innovative collections.



Bill Becker

CEO AND DESIGN DIRECTOR

Bill's mission has always been to develop unique and innovative furniture that enhances the quality of life. As BDI's CEO and Design Director, he continues this commitment by leading the effort to create designs which have a classic modernism and timeless style.



Matthew Weatherly

ASSOCIATE DESIGN DIRECTOR

Matthew's design direction is heavily influenced by Danish modern style and inspired by soft minimalism. He studied Scandinavian design, architecture, and woodworking at the Royal Danish Academy of Fine Arts, and holds a degree in Industrial Design from Pratt Institute.



BDIUSA.COM



Jeff Bare

Jeff combines a thorough understanding of construction and design to create furniture that functions as well as it looks. With a playful yet modern approach, Jeff's eye focuses on the way in which a design is experienced. From conception to production, his understanding of material resources and manufacturing methods ensures that every design is thoughtfully engineered with attention to detail. Jeff studied Industrial Design at Philadelphia University.



Al Glass

Clean and understated, Al's designs are simply sophisticated. Using simple proportions to create clear, classic pieces, he adds detail to make his designs stand out above the crowd, often embellishing them with simple details inspired by his life at the beach.



Jason Guidry

With a passion for creating innovative designs that blur the line between form and function—and with an attention to detail that makes for a unique expression—Jason is constantly striving to create that perfect experience for the end user.



Louis A. Lara

Louis designs with a sculptor's eye for form and detail. His designs have an innate sense of proportion and grace. The simplicity of his styling transcends fads and momentary trends to have a timeless appeal. Always refined, Louis' designs have a sculptural simplicity that is not only beautiful but functional.

BDI's wood finishes are comprised of a combination of hardwoods and natural hardwood veneers. The beauty of wood lies in the infinite variations of grain, texture, and color that develop as a tree grows. As wood is a natural product, it is affected by weather, climate, soil, light, and growth patterns.

Variations in wood pattern and color are to be expected from one piece to the next, and will even vary from one panel to another. It is this organic characteristic of real wood that ensures that each design is a unique work of nature.



CHARCOAL STAINED ASH



EBONIZED ASH

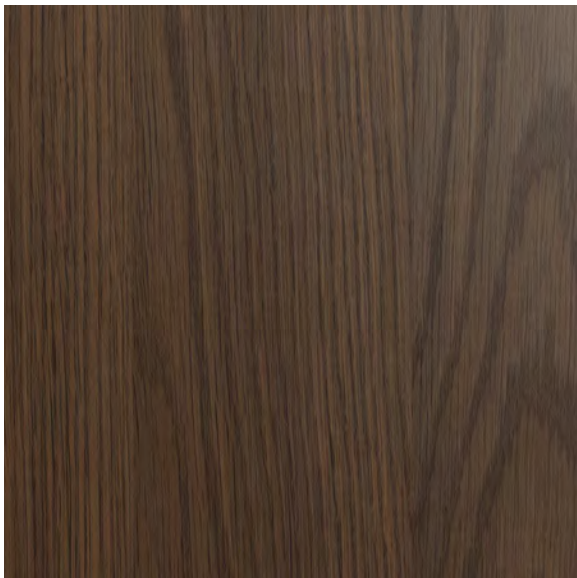

TOASTED OAK



WASHED OAK



SATIN WHITE ON OAK



CHOCOLATE STAINED WALNUT



NATURAL WALNUT

These printed swatches approximate the appearance of BDI's finishes, but are for illustration purposes only. A design's actual finish may vary somewhat from what is observed on a printed swatch, BDI's website or a physical sample.



CLAY

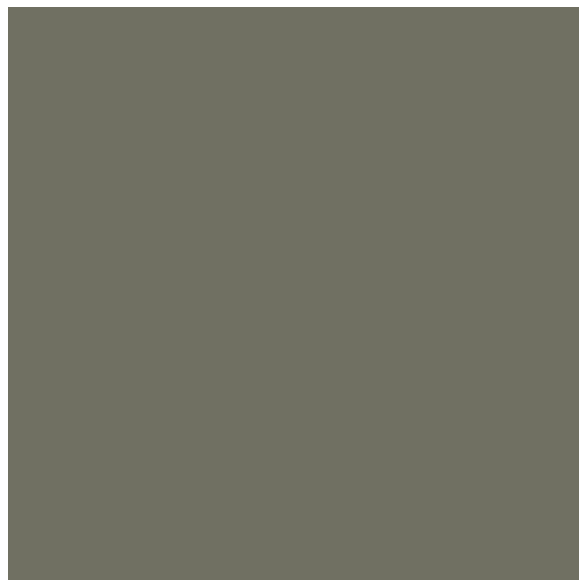

MOSS



OCEAN

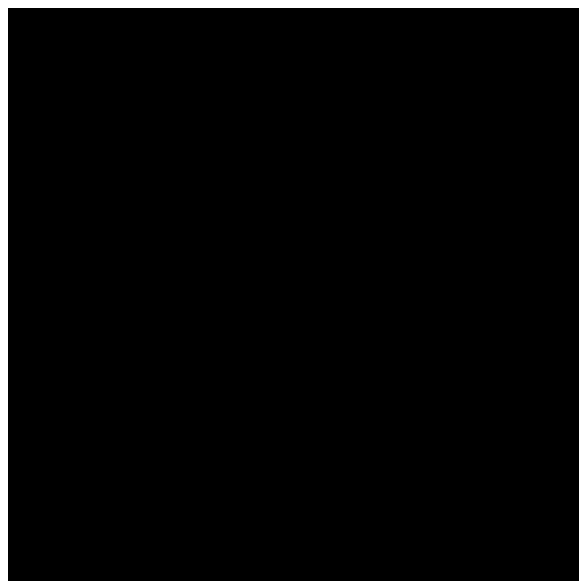

PEPPER

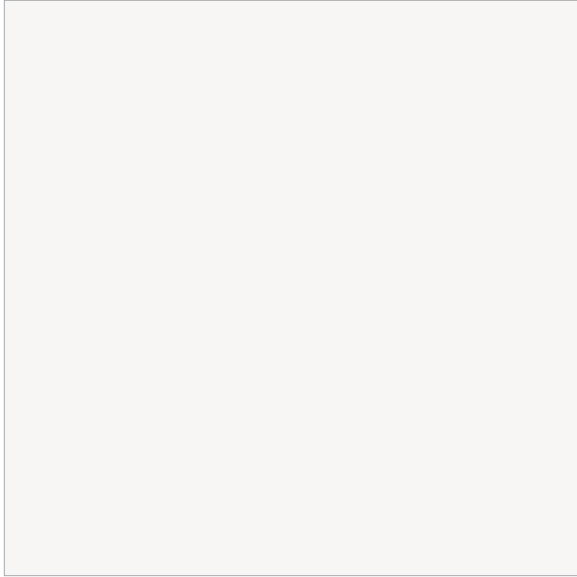

SALT

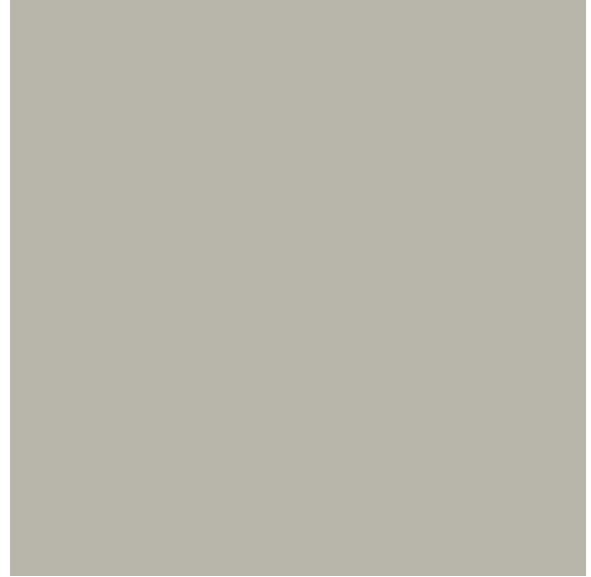

STONE

Thermally fused laminate (TFL) surfaces provide consistent characteristics and offers excellent heat, moisture, stain, and wear resistance. TFL is made by fusing a resin-impregnated sheet of wood pulp directly to a substrate, bonding to create a consistent pattern, uniform in strength and free of defects.



SEPIA TFL



STRATA TFL

These printed swatches approximate the appearance of BDI's finishes, but are for illustration purposes only. A design's actual finish may vary somewhat from what is observed on a printed swatch, BDI's website or a physical sample.



BRUSHED BRASS

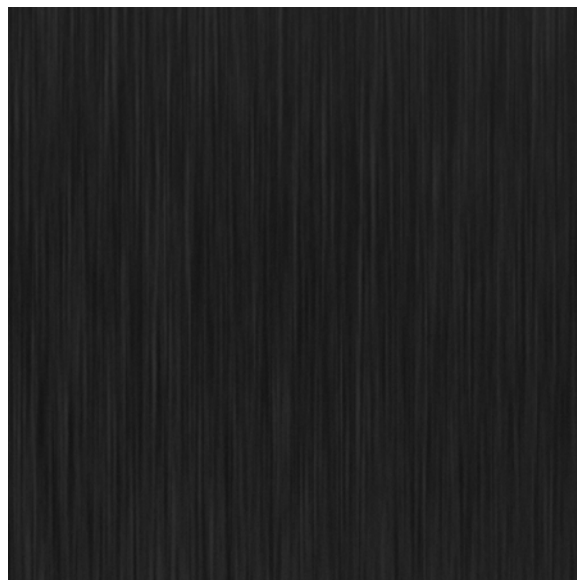

BRUSHED CARBON

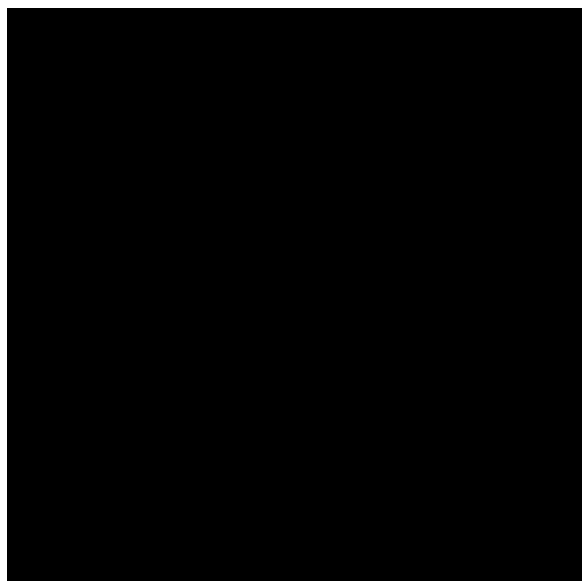

SATIN BLACK

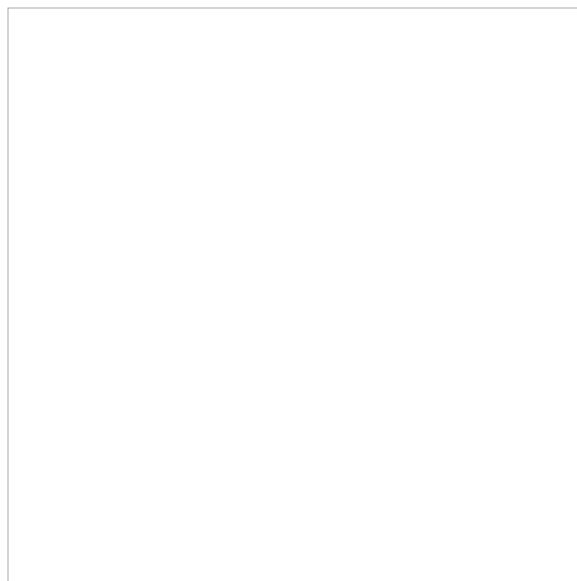

SATIN WHITE



ALTO GREY PORCELAIN



CIRRUS WHITE PORCELAIN



NIMBUS BLACK PORCELAIN

These printed swatches approximate the appearance of BDI's finishes, but are for illustration purposes only. A design's actual finish may vary somewhat from what is observed on a printed swatch, BDI's website or a physical sample.

Request a Finish Swatch

Finish swatch cards are available for BDI's most popular wood finishes. These printed cards approximate the finish your customer can expect. Naturally, the variations in real wood and wood veneers will ensure that each piece's finish is an original work of art.

Order finish swatches at
bdiusa.com/finishes



DESIGNED FOR MODERN LIVING



BDIUSA.COM